

Wireless Bridge BR-300AN

User's Guide



Index

1. Introduction.....	1
1-1. Introduction	1
Disclaimers.....	1
Trademarks	1
1-2. Safety Instructions	2
1-3. Product Information and Customer Services.....	5
Product Information	5
Customer Support Center	5
2. About BR-300AN	7
2-1. Features.....	8
2-2. Parts and Functions	10
2-3. Hardware Specification	12
2-4. Software Specification.....	14
2-5. Use of Radio Waves.....	15
Notes on Usage	15
2-6. Notes on Security	17
2-7. OpenSSL License	18
3. Before You Begin	21
3-1. Operating Mode	21
Single Client Mode.....	22
Multi-Client Mode	23
3-2. Configuration Method.....	24
Easy Configuration Using Configuration Mode.....	25
Wireless Configuration Using Smart Wireless Setup (Push Switch).....	26
Wireless Configuration Using Smart Wireless Setup (PIN Code)	27
3-3. Necessary Wireless Setting Information.....	28

4. How to Configure BR-300AN	29
4-1. Easy Configuration Using Configuration Mode.....	30
Starting BR-300AN in Configuration Mode.....	30
Configuration.....	32
Connecting Non-wireless Devices.....	36
4-2. Configuration Using Smart Wireless Setup (Push Switch).....	38
Configuration.....	39
Connecting Non-wireless Devices.....	43
4-3. Configuration Using Smart Wireless Setup(Pin Code)	45
Starting BR-300AN in Configuration Mode.....	46
Checking a PIN Code.....	48
Configuration.....	50
Connecting Non-wireless Devices.....	52
5. List of Functions	55
5-1. How to Access Web Configuration Interface.....	55
Starting BR-300AN in Configuration Mode.....	56
Configuration via Web Configuration Interface	58
5-2. IEEE802.1X Authentication	59
Network Configuration.....	59
IEEE802.1X Authentication.....	61
Certificate Standard.....	62
MAC Address Filtering.....	63
Before Using the IEEE802.1X Authentication	63
IEEE802.1X Authentication Settings	64
5-3. Saving Log.....	67
Types of Log.....	67
Retrieving/Deleting System Log	71
Retrieving Event Log	79

Time Synchronization of Log.....	84
5-4. Address Management Table.....	85
About Address Management Table Feature	85
Registering Address to Management Table.....	86
Deleting Address from Management Table.....	88
5-5. Maintenance	90
Restarting.....	90
Factory Default Configuration	92
Firmware Update	94
A. Appendix.....	95
A-1. List of All Settings	95
A-2. Troubleshooting	108



1. Introduction

Thank you for purchasing the Wireless Bridge BR-300AN (hereinafter the "BR-300AN").

1-1. Introduction

This manual provides information on how to configure and use the BR-300AN. Please read the Safety Instructions carefully before you begin.

Disclaimers

- The unauthorized transfer or copying of the content of this manual, in whole or in part, without prior written consent is expressly prohibited by law.
- The content of this manual is subject to change without notice.
- This manual was prepared to accurately match the content of each OS, but the actual information shown on the computer monitor may differ from the content of this manual due to future OS version upgrades, modifications, and other changes.
- Although every effort was made to prepare this manual with the utmost accuracy, Silex Technology will not be held liable for any damages as a result of errors, setting examples, or other content.

Trademarks



- Microsoft and Windows are registered trademarks of Microsoft Corporation in the United States and/or other countries.
- Wi-Fi, Wi-Fi Protected Setup (WPS), Wi-Fi Protected Access (WPA), WPA2 are trademarks or registered trademarks of Wi-Fi Alliance.
- Other company names and product names contained in this manual are trademarks or registered trademarks of their respective companies.

1-2. Safety Instructions







This page provides the safety instructions for safe use of BR-300AN.

To ensure safe and proper use, please read the following information carefully before using BR-300AN. The safety instructions include important information on safe handling of BR-300AN and on general safety issues.

< Meaning of the warnings >

	Warning	"Warning" indicates the existence of a hazard that could result in death or serious injury if the safety instruction is not observed.
	Caution	"Caution" indicates the existence of a hazard that could result in serious injury or material damage if the safety instruction is not observed.

< Meaning of the symbols >

	This symbol indicates the warning and caution. (Example:  "Danger of the electric shock")
	This symbol indicates the prohibited actions. (Example:  "Disassembly is prohibited")
	This symbol indicates the actions users are required to observe. (Example:  "Remove the AC plug from an outlet")



Warning

	<p>* Do not allow physical impact. When damaged, turn off the connected devices, unplug the AC plug of BR-300AN from a power outlet and contact your point of purchase. Failure to take this action could cause fire or an electrical shock.</p>
	<p>* In the following cases, turn off the connected devices and unplug the AC plug of BR-300AN from a power outlet and contact your point of purchase. Failure to take this action could cause fire or an electrical shock.</p>
	<p>* When BR-300AN emits a strange smell, smoke or sound or becomes too hot to touch. * When foreign objects (metal, liquid, etc.) gets into BR-300AN.</p>
	<p>* Keep the cords and cables away from children. It may cause an electrical shock or serious injury.</p>
	<p>* If a ground wire is supplied with your device to use with, connect it to the ground terminal in order to prevent an electrical shock. Do not connect the ground wire to gas pipe, water pipe, lighting rod or telephone ground wire. It may cause malfunction.</p>
	<p>* Do not disassemble or modify BR-300AN. It may cause fire, electrical shock or malfunction. * Do not disassemble or modify the AC adaptor that came with BR-300AN. It may cause fire, electrical shock or malfunction.</p>



Caution

	* Do not pull on the cord to disconnect the plug from the power supply. The cord may be broken, which could result in fire or an electrical shock.
	* When removing BR-300AN, disconnect the AC plugs of both BR-300AN and the other devices you are using with. * Use the AC adaptor supplied with BR-300AN. Other AC adaptors may cause malfunction. * Verify all codes or cables are plugged correctly before using BR-300AN. * When BR-300AN will not be used for a long time, unplug the power cables of BR-300AN and the other devices you are using with.
	* Do not use or store BR-300AN under the following conditions. It may cause malfunction. <ul style="list-style-type: none">- Locations subject to vibration or shock- Shaky, uneven or tilted surfaces- Locations exposed to direct sunlight- Humid or dusty places- Wet places (kitchen, bathroom, etc.)- Near a heater or stove- Locations subject to extreme changes in temperature- Near strong electromagnetic sources (magnet, radio, wireless device, etc.)

1-3. Product Information and Customer Services

Product Information

The services below are available from the Silex Technology website. For details, please visit the Silex Technology website.

URL	
USA / Europe	https://www.silextechnology.com/

- Latest firmware download
- Latest software download
- Latest manual download
- Support information (FAQ)

Customer Support Center

Customer Support is available by e-mail or telephone for any problems that you may encounter. If you cannot find the relevant problem in this manual or on our website, or if the corrective procedure does not resolve the problem, please contact Silex Technology Customer Support.

Contact Information		
USA	+1-657-218-5199	support@silexamerica.com
Europe	+49-(0)2154-88967-0	support@silexeurope.com



Note

- Visit the Silex Technology website (<https://www.silextechnology.com/>) for the latest FAQ and product information.

2. About BR-300AN

BR-300AN is the wireless bridge which allows to use a non-wireless device (10/100/1000BASE-T network device) as a wireless device. With 2.4G/5GHz band support, various non-wireless devices can easily be connected over a wireless network.

The enterprise security feature will ensure safe and secure use of wireless communication at an office, factory, etc. where a higher security is required.

2-1. Features

BR-300AN has the following features:

Giving unlimited locations for your non-wireless devices

As you do not have to care wiring conditions in order to establish your environment, choices of location greatly expand in any kinds of scenes such as office, factory, school, commercial facility, etc. where the layout change is frequently required or effective layout of equipment needs to be carefully considered for a work line. Also, cost reductions is largely expected as you will no longer have to pay for wiring construction.

IEEE 802.11a/b/g/n

BR-300AN supports communications at both 2.4GHz/5GHz bands. Using 5GHz band will help to avoid radio interference with 2.4GHz band which is most commonly used in the market.

Advanced security

The following security features are supported:

- WEP (64bit/128bit)
- WPA-PSK(AUTO/AES),WPA2-PSK (AES)
- IEEE 802.1X EAP-TLS, PEAP, EAP-TTLS, EAP-FAST, LEAP

Two types of operating mode

[Single Client Mode]

- Bridges a single non-wireless device connected to a LAN port of the BR-300AN over wireless network.
- For the MAC address to use for wireless LAN connection, the MAC address of the device connected to a LAN port of the BR-300AN will be used (MAC address transparent feature).
- Stops bridging when someone changed the device being connected to a wired LAN port of the BR-300AN to the other one (security feature).

[Multi-Client Mode]

- Up to 16 non-wireless devices can be bridged over wireless network if a HUB is connected to a LAN port of the BR-300AN.
- For the MAC address to use for wireless LAN connection, the MAC address of the BR-300AN will be used.

On-board storage chip with 2GB memory

The operating log data can be stored in the on-board storage chip for a long period of time. This will help you to quickly resolve the troubles that may occur during the use of BR-300AN.

Easy access to the Web configuration interface

Without changing the setting of the PC you use for setup, the Web configuration interface of BR-300AN can easily be accessed.

AMC Manager (non-free program) / AMC Finder (free program)

BR-300AN supports the total management software, "AMC Manager" and "AMC Finder".

The AMC Manager provides the useful features as follows:

- Remote device control and monitoring
- Bulk configuration and firmware updates
- System time synchronization (version 3.2.0 or later)



Note

- To use the functions above, your Access Point or wireless router needs to support the same functions.
- For details on the "AMC Manager" and "AMC Finder", please visit our homepage.
- To use the "AMC Manager" and "AMC Finder", an IP address needs to be configured to the BR-300AN.
- BR-300AN can be used in Infrastructure mode only. Ad hoc mode is not supported.

2-2. Parts and Functions

The parts name and functions are as follows:

Front

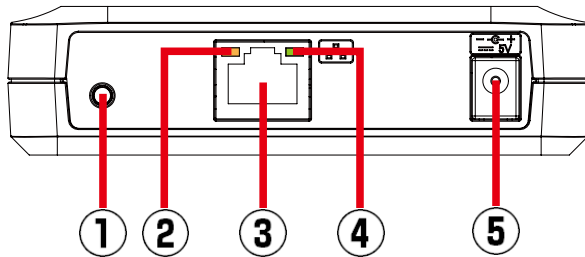

(1)	Push Switch	Start in Configuration Mode	Press and hold this switch for 5 sec while BR-300AN is active.
		Wireless configuration using Smart Wireless Setup	Press and hold this switch for 10 sec while BR-300AN is active.
		Factory default configuration	Press and hold this switch while turning on BR-300AN and release it when the WLAN LED turns from Green to Red.
(2)	Status LED (Green / Orange)	Blink (Orange)	Waits for connection when the Link LED is turned off. Handles data communication when the Link LED is turned on.
(3)	LAN port	Connect a network cable.	
(4)	Link LED (Green)	ON	Has connected to a wired LAN.
(5)	AC connector	Connect an AC adaptor.	

Top

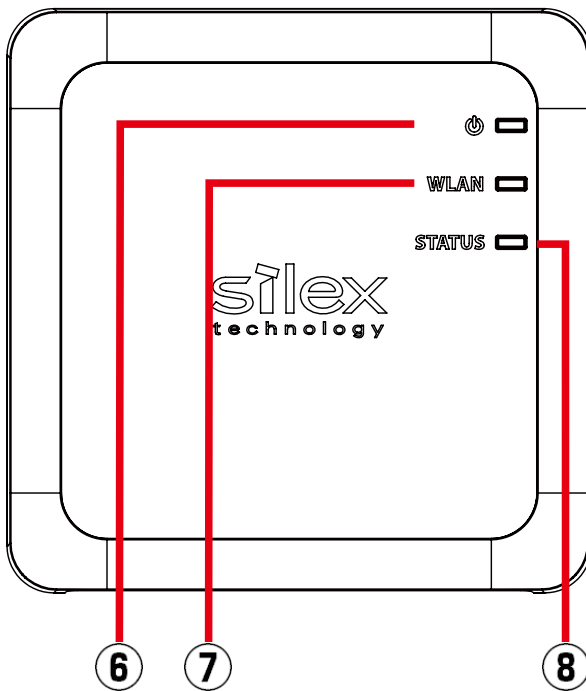

Bottom

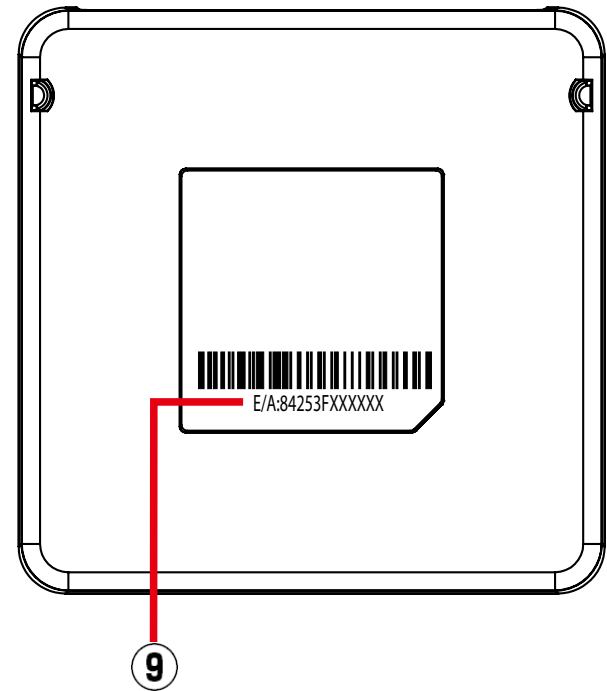

(6)	POWER LED (Green/Red)	ON (Green)	Powered on
		ON (Red)	Powered on and ready
(7)	WLAN LED (Green/Red)	ON (Green)	Operating in Infrastructure mode.
		Blink (Green)	Processing wireless configuration using Smart Wireless Setup.
		* Blinks Green together with the STATUS LED when operating in Configuration Mode. * Turns from Green to Red during the factory default configuration.	
(8)	STATUS LED (Green/Red)	ON (Green)	Connection is established.
		Blink (Green)	Handles data communication.
		* Blinks Green together with the WLAN LED when operating in Configuration Mode.	
(9)	MAC Address	MAC Address of the LAN port on BR-300AN	

2-3. Hardware Specification

Operating environment	Temperature : 0 degrees to +40 degrees
	Humidity : 20% to 80%RH (Non-condensing)
Storage environment	Temperature : -10 degrees to +50 degrees
	Humidity : 20% to 90%RH (Non-condensing)
EMI	VCCI Class-B
	FCC Part15 SubPart B Class-B
	ICES-003 Class-B
	CE EN301489-1/-17(EN55032 Class-B)
Wired network interface	10BASE-T/100BASE-TX/1000BASE-T (Auto-sensing) :1 port Auto MDI/MDIX
Wireless network interface	IEEE 802.11a/b/g/n
Channel	(US/CA) 2.4GHz: 1-11ch 5GHz: (W52) 36,40,44,48 (W53) 52,56,60,64 (W56) 100,104,108,112,116,132,136,140 (W58) 149,153,157,161,165
	(EU) 2.4GHz: 1-13ch 5GHz: (W52) 36,40,44,48 (W53) 52,56,60,64 (W56) 100,104,108,112,116,120,124,128,132,136,140
Push Switch	1
LED	Top POWER (Green / Red) WLAN (Green / Red) STATUS (Green / Red)
	LAN Port Status (Green / Orange) Link (Green)
Compatible devices	Network devices with LAN port (RJ-45)
Max number of connectable devices	When operating in Single Client Mode : 1 device
	When operating in Multi-Client Mode : 16 devices

FCC / IC Notice



FCCID : N6C-SXPCEAN2
IC : 4908A-SXPCEAN2

Channel Selection

For product available in the USA/Canada market, only channel 1~11 can be operated. Selection of other channels is not possible.

Fcc Rules Part 15

FCC CAUTION

Changes or modifications not expressly approved by the party responsible for compliance could void the user's authority to operate the equipment.

FCC Rules, Part 15 §15.19(a)(3) / IC RSS Gen §8.4

Below sentences must be indicated on the final product which contains this module inside.

This device complies with Part 15 of FCC Rules and Industry Canada licence-exempt RSS standard(s). Operation is subject to the following two conditions: (1) this device may not cause interference, and (2) this device must accept any interference, including interference that may cause undesired operation of this device.

Le présent appareil est conforme à la partie 15 des règles de la FCC et CNR d'Industrie Canada applicables aux appareils radio exempts de licence. L'exploitation est autorisée aux deux conditions suivantes : (1) l'appareil ne doit pas produire de brouillage, et (2) l'appareil doit accepter tout brouillage subi, même si le brouillage est susceptible d'en compromettre le fonctionnement.

FCC Rules Part 15 Subpart C §15.247 and Subpart E / IC RSS-102 §2.6

This equipment complies with FCC/IC radiation exposure limits set forth for an uncontrolled environment and meets the FCC radio frequency (RF) Exposure Guidelines and RSS-102 of the IC radio frequency (RF) Exposure rules. This equipment should be installed and operated keeping the radiator at least 20cm or more away from person's body.

Cet équipement est conforme aux limites d'exposition aux rayonnements énoncées pour un environnement non contrôlé et respecte les règles les radioélectriques (RF) de la FCC lignes directrices d'exposition et d'exposition aux fréquences radioélectriques (RF) CNR-102 de l'IC. Cet équipement doit être installé et utilisé en gardant une distance de 20 cm ou plus entre le radiateur et le corps humain.

FCC Rules Part 15 Subpart E §15.407(c)

Compliance with FCC requirement 15.407(c)

Data transmission is always initiated by software, which is the passed down through the MAC, through the digital and analog baseband, and finally to the RF chip. Several special packets are initiated by the MAC. These are the only ways the digital baseband portion will turn on the RF transmitter, which it then turns off at the end of the packet. Therefore, the transmitter will be on only while one of the aforementioned packets is being transmitted.

In other words, this device automatically discontinues transmission in case of either absence of information to transmit or operational failure.

FCC Rules Part 15 Subpart E §15.407(g)

Frequency Tolerance: +/-20 ppm

FCC Rules Part 15 Subpart C §15.247(g) / Subpart E

This device and its antenna(s) must not be co-located or operation in conjunction with any other antenna or transmitter.

RSS-Gen §8.3

This radio transmitter 4908A-SXPCEAN2 has been approved by Industry Canada to operate with the antenna types listed below with the maximum permissible gain and required antenna impedance for each antenna type indicated. Antenna types not included in this list, having a gain greater than the maximum gain indicated for that type, are strictly prohibited for use with this device.

Le numéro IC du présent émetteur radio 4908A-SXPCEAN2 a été approuvé par Industrie Canada pour fonctionner avec les types d'antenne énumérés ci-dessous et ayant un gain admissible maximal et l'impédance requise pour chaque type d'antenne. Les types d'antenne non inclus dans cette liste, ou dont le gain est supérieur au gain maximal indiqué pour ce type, sont strictement interdits pour l'exploitation avec cet appareil.

- Antenna type
External printed PCB antenna

- Model
H2B1PC1A1C

- Antenna Gain
2.4GHz : +1.8dBi (Peak)
5GHz : +3.9 dBi (Peak)

RSS-210

5150-5250 MHz and 5250-5350 MHz bands are restricted to indoor operations only.

High-power radars are allocated as primary users (i.e. priority users) of the bands 5250-5350 MHz and 5650-5850 MHz and that these radars could cause interference and/or damage to LE-LAN devices.

La bandes 5150-5250 MHz et 5250-5350 MHz ont restreinte à une utilisation à l'intérieur seulement.

Les radars de haute puissance sont désignés comme utilisateurs principaux (c'est-à dire utilisateurs prioritaires) pour les bandes 5250-5350 MHz et 5650-5850 MHz, et que ces radars peuvent provoquer du brouillage et/ou des dommages aux dispositifs LAN-EL.

WARNING

The FCC / The Industry Canada regulations provide that changes or modifications not expressly approved by the party responsible for compliance could void the user's authority to operate the equipment.

CE Notice



2-4. Software Specification

Configuration Mode

TCP/IP	Network layer	ARP, IP
	Transport layer	TCP, UDP
	Application layer	HTTP, DNS(simple reply function only), DHCP (simple server function only), NetBIOS over TCP/IP (Name Service only), JCP, FLDP, FLDP/BR * JCP, FLDP, FLDP/BR are the silex proprietary protocols.

Normal Mode (Single Client Mode)

TCP/IP	Application layer	NTP, FLDP, FLDP/BR (only on a LAN port), SX_SMP * FLDP, FLDP/BR, SX_SMP are the silex proprietary protocols.
--------	-------------------	---

- This bridges other protocols.

Normal Mode (Multi-Client Mode)

TCP/IP	Application layer	NTP, FLDP, FLDP/BR (only on a LAN port), SX_SMP * FLDP, FLDP/BR, SX_SMP are the silex proprietary protocols.
--------	-------------------	---

- This bridges TCP/IP (IPv4, IPv6) only.

2-5. Use of Radio Waves

Notes on Usage

Do not use BR-300AN near the following devices or places.

- Microwave, scientific instruments, pacemaker or other medical equipment, etc.
- Licensed radio station in a factory
- Small power radio station (A non-licensed radio station)

These devices may use the same band. If you use BR-300AN near these devices, the radio waves emitted from BR-300AN may interfere with them.

Do not use BR-300AN near a cellular phone, TV or Radio.

A cellular phone, TV and radio use a different radio band than our products. Generally, if they are used near BR-300AN, it will not cause any problems. However, when they approximate BR-300AN, sound or image noise may occur.

If there is reinforced concrete/metal between wireless devices, they may not connect.

BR-300AN can connect through wood or glass, but may have troubles connecting through reinforced concrete/metal.

BR-300AN complies with the certification of conformance to technical standards.

Please pay attention to the following points:

- Please do not disassemble or remodel the product. Such action is prohibited by law.
- Please do not remove the certificate label. Using the product without a label is prohibited.

Wireless devices using 2.4GHz band

The same frequency band of BR-300AN is used for a microwave, industry, science, medical equipment and licensed in room or low power (non-licensed) radio stations.

- Before you use BR-300AN, check that it does not interfere with other devices.
- If interference occurs, stop using BR-300AN or change the wireless band. Please consider to create a wall between these devices to avoid interference. Contact us for possible solution.

*The meaning of the symbols in the bottom of the unit:

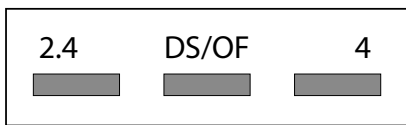

2.4	: Wireless devices using 2.4GHz frequency band
DS/OF	: DS-SS or OFDM is used as modulation.
4	: The range of interference is equal to or lower than 40m.
	: All bands can be used to avoid interference.

Notes on using 5GHz band

- Use of 5.2GHz band (W52) and 5.3GHz band (W53) outdoors is prohibited by the radio regulations. Use only W56 channels then.

2-6. Notes on Security

Because a wireless LAN uses electromagnetic signals instead of a network cable to establish communication with network devices, it has the advantage of allowing devices to connect to the network easily. However, a disadvantage of this is that within a certain range, the electromagnetic signals can pass through barriers such as walls, and if security countermeasures are not implemented in some way, problems such as the following may occur.

- Communication is intercepted by a third party
- Unauthorized access to the network
- Leakage of personal information (ID and Card information)
- Spoofing and the falsification of intercepted data
- System crashes and data corruption

Nowadays, wireless LAN cards or access points are equipped with security measures that address such security problems, so that you can enable security-related settings for wireless LAN products in order to reduce the likelihood of problems occurring.

We recommend that you make yourself fully acquainted with the possible implications of what might happen if you use a wireless product without enabling security features, and that you configure security-related settings and use wireless products at your own responsibility.

2-7. OpenSSL License

This product includes software developed by the OpenSSL Project for use in the OpenSSL Toolkit.

(<http://www.openssl.org/>)

OpenSSL License

/* =====

* Copyright (c) 1998-2008 The OpenSSL Project. All rights reserved.

*

* Redistribution and use in source and binary forms, with or without
* modification, are permitted provided that the following conditions
* are met:

*

* 1. Redistributions of source code must retain the above copyright
* notice, this list of conditions and the following disclaimer.

*

* 2. Redistributions in binary form must reproduce the above copyright
* notice, this list of conditions and the following disclaimer in
* the documentation and/or other materials provided with the
* distribution.

*

* 3. All advertising materials mentioning features or use of this
* software must display the following acknowledgment:
* "This product includes software developed by the OpenSSL Project
* for use in the OpenSSL Toolkit. (<http://www.openssl.org/>)"

*

* 4. The names "OpenSSL Toolkit" and "OpenSSL Project" must not be used to
* endorse or promote products derived from this software without
* prior written permission. For written permission, please contact
* openssl-core@openssl.org.

*

* 5. Products derived from this software may not be called "OpenSSL"
* nor may "OpenSSL" appear in their names without prior written
* permission of the OpenSSL Project.

*

* 6. Redistributions of any form whatsoever must retain the following
* acknowledgment:

* "This product includes software developed by the OpenSSL Project
* for use in the OpenSSL Toolkit (<http://www.openssl.org/>)"

*

```

* THIS SOFTWARE IS PROVIDED BY THE OpenSSL PROJECT ``AS IS" AND ANY
* EXPRESSED OR IMPLIED WARRANTIES, INCLUDING, BUT NOT LIMITED TO, THE
* IMPLIED WARRANTIES OF MERCHANTABILITY AND FITNESS FOR A PARTICULAR
* PURPOSE ARE DISCLAIMED. IN NO EVENT SHALL THE OpenSSL PROJECT OR
* ITS CONTRIBUTORS BE LIABLE FOR ANY DIRECT, INDIRECT, INCIDENTAL,
* SPECIAL, EXEMPLARY, OR CONSEQUENTIAL DAMAGES (INCLUDING, BUT
* NOT LIMITED TO, PROCUREMENT OF SUBSTITUTE GOODS OR SERVICES;
* LOSS OF USE, DATA, OR PROFITS; OR BUSINESS INTERRUPTION)
* HOWEVER CAUSED AND ON ANY THEORY OF LIABILITY, WHETHER IN CONTRACT,
* STRICT LIABILITY, OR TORT (INCLUDING NEGLIGENCE OR OTHERWISE)
* ARISING IN ANY WAY OUT OF THE USE OF THIS SOFTWARE, EVEN IF ADVISED
* OF THE POSSIBILITY OF SUCH DAMAGE.

```

```

* =====

```

```

*

```

```

* This product includes cryptographic software written by Eric Young
* (eay@cryptsoft.com). This product includes software written by Tim
* Hudson (tjh@cryptsoft.com).

```

```

*

```

```

*/

```

Original SSLeay License

```

-----

```

```

/* Copyright (C) 1995-1998 Eric Young (eay@cryptsoft.com)

```

```

* All rights reserved.

```

```

*

```

```

* This package is an SSL implementation written

```

```

* by Eric Young (eay@cryptsoft.com).

```

```

* The implementation was written so as to conform with Netscapes SSL.

```

```

*

```

```

* This library is free for commercial and non-commercial use as long as

```

```

* the following conditions are aheared to. The following conditions

```

```

* apply to all code found in this distribution, be it the RC4, RSA,

```

```

* lhash, DES, etc., code; not just the SSL code. The SSL documentation

```

```

* included with this distribution is covered by the same copyright terms

```

```

* except that the holder is Tim Hudson (tjh@cryptsoft.com).

```

```

*

```

```

* Copyright remains Eric Young's, and as such any Copyright notices in

```

```

* the code are not to be removed.

```

```

* If this package is used in a product, Eric Young should be given attribution

```

```

* as the author of the parts of the library used.

```

```

* This can be in the form of a textual message at program startup or

```

```

* in documentation (online or textual) provided with the package.

```

```

*

```

- * Redistribution and use in source and binary forms, with or without
- * modification, are permitted provided that the following conditions
- * are met:
- * 1. Redistributions of source code must retain the copyright
- * notice, this list of conditions and the following disclaimer.
- * 2. Redistributions in binary form must reproduce the above copyright
- * notice, this list of conditions and the following disclaimer in the
- * documentation and/or other materials provided with the distribution.
- * 3. All advertising materials mentioning features or use of this software
- * must display the following acknowledgement:
- * "This product includes cryptographic software written by
- * Eric Young (eay@cryptsoft.com)"
- * The word 'cryptographic' can be left out if the routines from the library
- * being used are not cryptographic related :-).
- * 4. If you include any Windows specific code (or a derivative thereof) from
- * the apps directory (application code) you must include an acknowledgement:
- * "This product includes software written by Tim Hudson (tjh@cryptsoft.com)"
- *
- * THIS SOFTWARE IS PROVIDED BY ERIC YOUNG ``AS IS" AND
- * ANY EXPRESS OR IMPLIED WARRANTIES, INCLUDING, BUT NOT LIMITED TO, THE
- * IMPLIED WARRANTIES OF MERCHANTABILITY AND FITNESS FOR A PARTICULAR
- * PURPOSE
- * ARE DISCLAIMED. IN NO EVENT SHALL THE AUTHOR OR CONTRIBUTORS BE LIABLE
- * FOR ANY DIRECT, INDIRECT, INCIDENTAL, SPECIAL, EXEMPLARY, OR CONSEQUENTIAL
- * DAMAGES (INCLUDING, BUT NOT LIMITED TO, PROCUREMENT OF SUBSTITUTE
- * GOODS
- * OR SERVICES; LOSS OF USE, DATA, OR PROFITS; OR BUSINESS INTERRUPTION)
- * HOWEVER CAUSED AND ON ANY THEORY OF LIABILITY, WHETHER IN CONTRACT,
- * STRICT
- * LIABILITY, OR TORT (INCLUDING NEGLIGENCE OR OTHERWISE) ARISING IN ANY WAY
- * OUT OF THE USE OF THIS SOFTWARE, EVEN IF ADVISED OF THE POSSIBILITY OF
- * SUCH DAMAGE.
- *
- * The license and distribution terms for any publically available version or
- * derivative of this code cannot be changed. i.e. this code cannot simply be
- * copied and put under another distribution license
- * [including the GNU Public License.]
- * /

3. Before You Begin

This chapter explains each operating mode and available configuration methods for BR-300AN as well as the wireless setting information you need to check out before the configuration.

3-1. Operating Mode

BR-300AN has 2 operating modes below.

Please use the one appropriate for your environment.

- Single Client Mode
- Multi-Client Mode

**Note**

- The operating mode can be configured on the Web configuration interface which can be accessed when the BR-300AN operates in Configuration Mode.
- By defaults, the operating mode is set to **Single-Client Mode**.

Single Client Mode

Use this mode when you connect a single non-wireless device to the BR-300AN. As the MAC address and IP address of the connected device are used for wireless LAN connection, you can use the device as if it is directly connected to a wireless LAN.

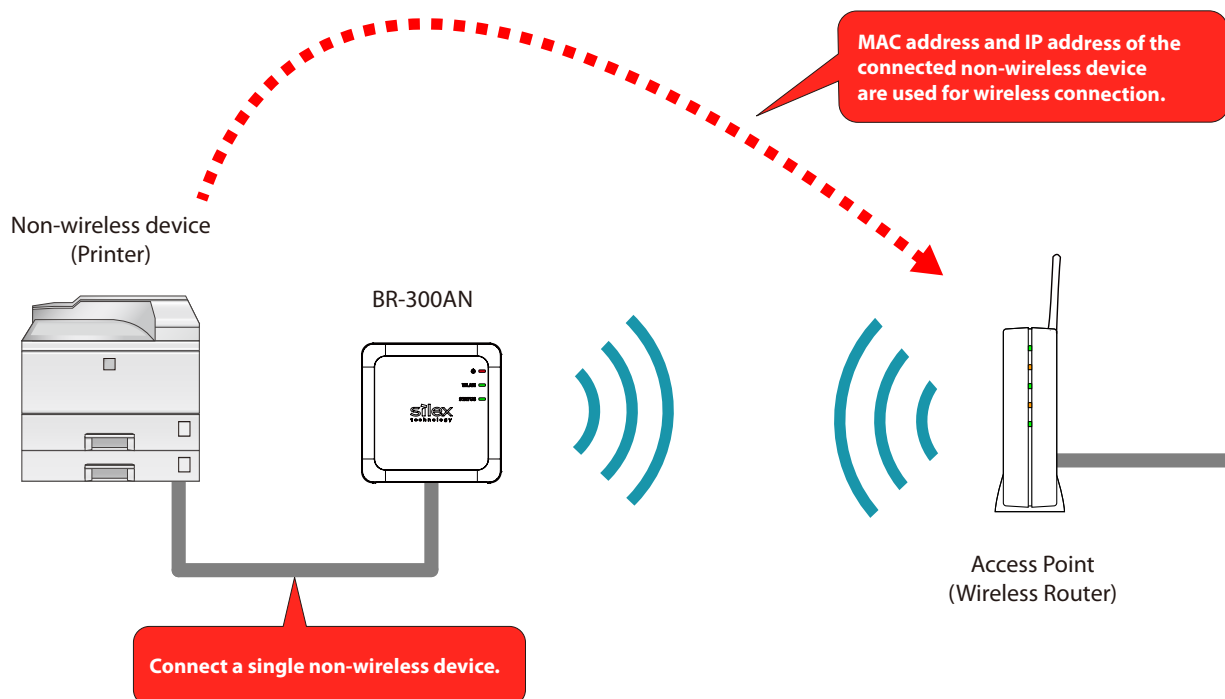

- Only one device can be connected to a LAN port.
- The following actions are treated as an error. If one of these occurs, the bridge function will abort.
 - Connecting multiple devices to a LAN port using a HUB
 - Changing the device connected to a LAN port to the other device while BR-300AN is running.
- If the connection is lost on a LAN port while communication is in progress, wireless bridging will be disabled until it is reconnected.
- The devices with multiple MAC addresses cannot be used (e.g. PC with a load balancing feature, etc).
- Due to restrictions of the protocols, "**View full map**" of "**Network and Sharing Center**" is not fully supported on Windows Vista / 7.

Multi-Client Mode

Use this mode when you connect multiple non-wireless devices to BR-300AN.

By using a HUB on the LAN port, up to 16 devices can be connected.

For wireless connection, the MAC address of BR-300AN and IP addresses of the connected devices will be used.

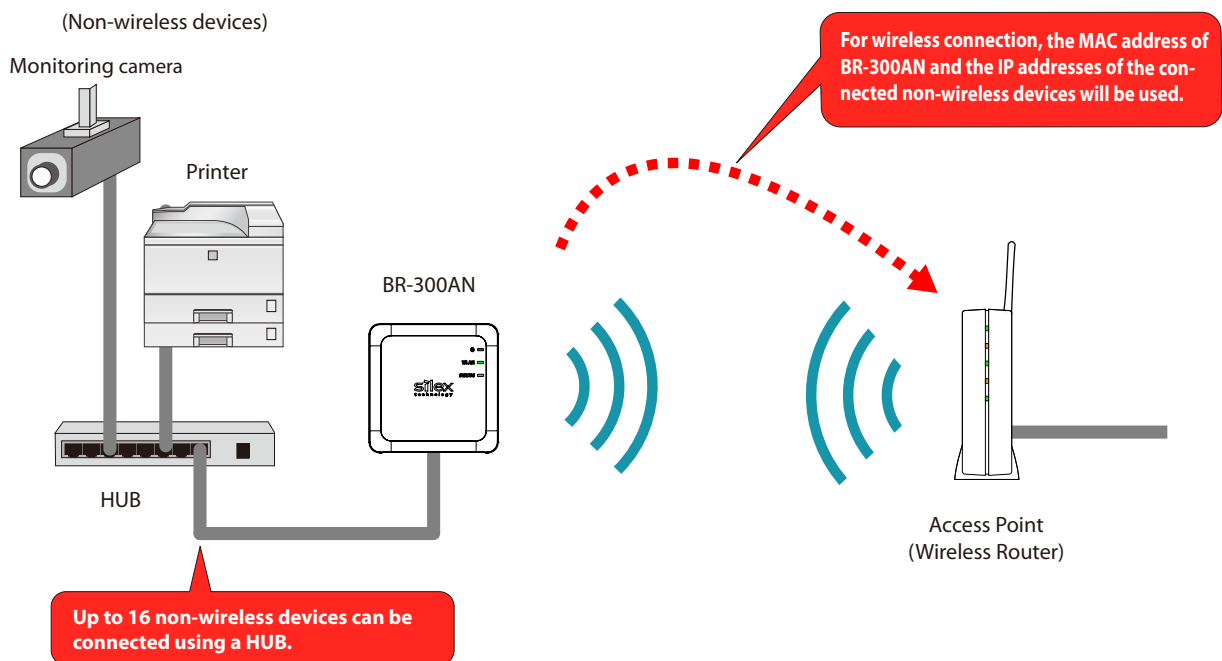

TIP

- The devices with multiple MAC addresses cannot be used (e.g. PC with a load balancing feature, etc).
- BR-300AN bridges TCP/IP (IPv4 and IPv6) only. Other protocols are not supported.
- BR-300AN does not support bridging the following IPv6 packets.
 - Inverse Neighbor Advertisement
 - Fragment Header
 - Authentication Header
 - Encapsulating Security Payload

3-2. Configuration Method

There are 3 configuration methods as follows.

Please select the one appropriate for your environment.

- Easy configuration using Configuration Mode
- Wireless configuration using Smart Wireless Setup (Push Switch)
- Wireless configuration using Smart Wireless Setup (PIN code)

Easy Configuration Using Configuration Mode

In this configuration method, you connect the BR-300AN to a PC using a network cable to configure the settings from the PC.

By connecting the BR-300AN to the PC and starting it in Configuration Mode, the Web configuration interface can be accessed. Select the Access Point the BR-300AN should wirelessly connect to and enter the Network Key on the configuration interface.

Depending on your environment, you may need to check the wireless LAN information beforehand.

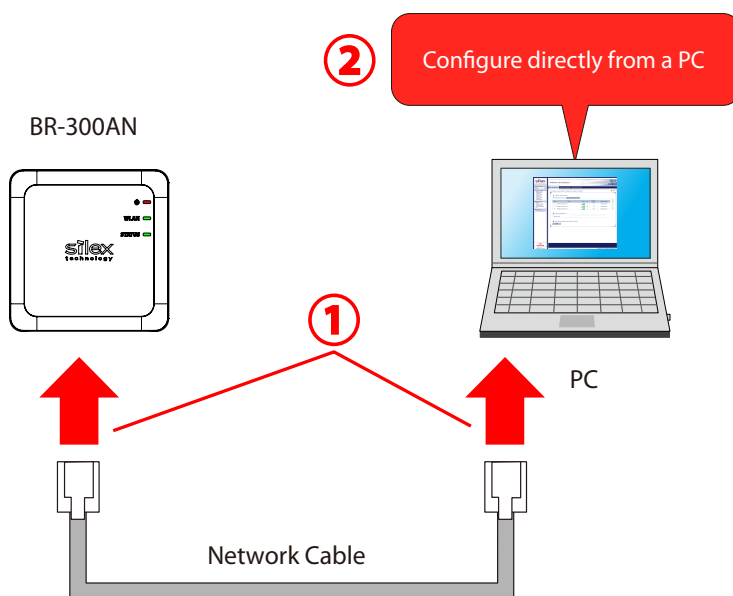

Note

In this configuration method, only "**SSID**" and "**Network Key**" are needed to connect to a wireless LAN, however, further configuration is required in the following cases.

- Access Point is operating in a stealth mode.
- Access Point is using the Shared authentication
- Access Point is using the Open authentication and the WEP key index other than "1".
- Too many wireless networks are active (up to 32 wireless networks can be shown by BR-300AN).

Wireless Configuration Using Smart Wireless Setup (Push Switch)

In this configuration method, you can automatically configure the wireless settings by pressing the wireless connection button on your Access Point (wireless router) and the push switch on BR-300AN. You will not have to get wireless setting information beforehand, as configuration is automatically handled by the BR-300AN and your Access Point.

For this configuration method, an Access Point supporting WPS(Wi-Fi Protected Setup) is required. To see if your Access Point supports WPS, refer to the operation manual that came with your Access Point or contact the manufacturer.

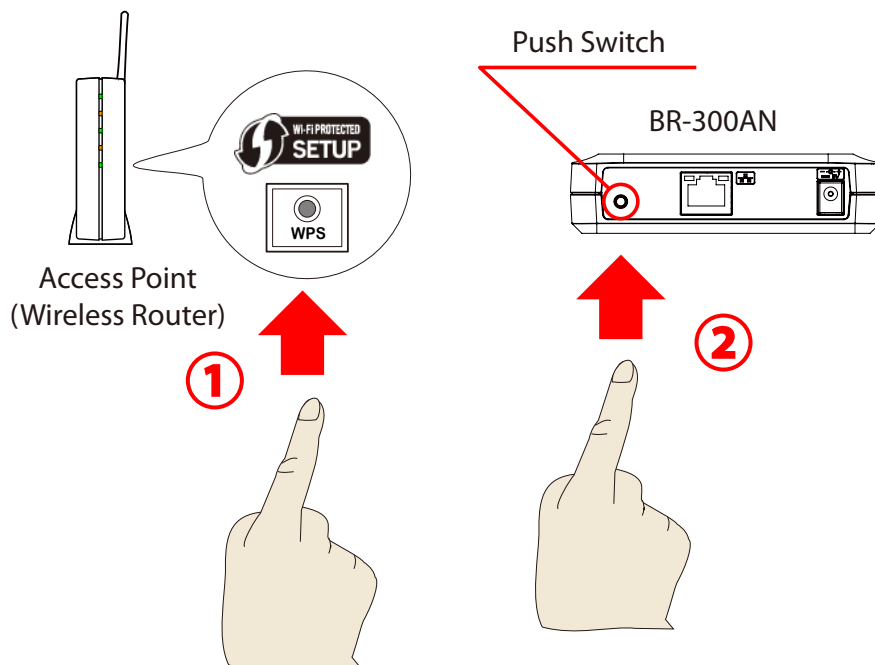

Wireless Configuration Using Smart Wireless Setup (PIN Code)

In this configuration method, you can automatically configure the wireless settings by entering the PIN code of BR-300AN on your Access Point (wireless router).

The PIN code can be identified from the Web configuration interface of BR-300AN. To access the Web configuration interface, connect the BR-300AN directly to a PC using a network cable and start it in Configuration Mode.

You will not have to get wireless setting information beforehand, as configuration is automatically handled by the BR-300AN and your Access Point. For this configuration method, an Access Point supporting WPS(Wi-Fi Protected Setup) is required. To see if your Access Point supports WPS, refer to the operation manual that came with your Access Point or contact the manufacturer.

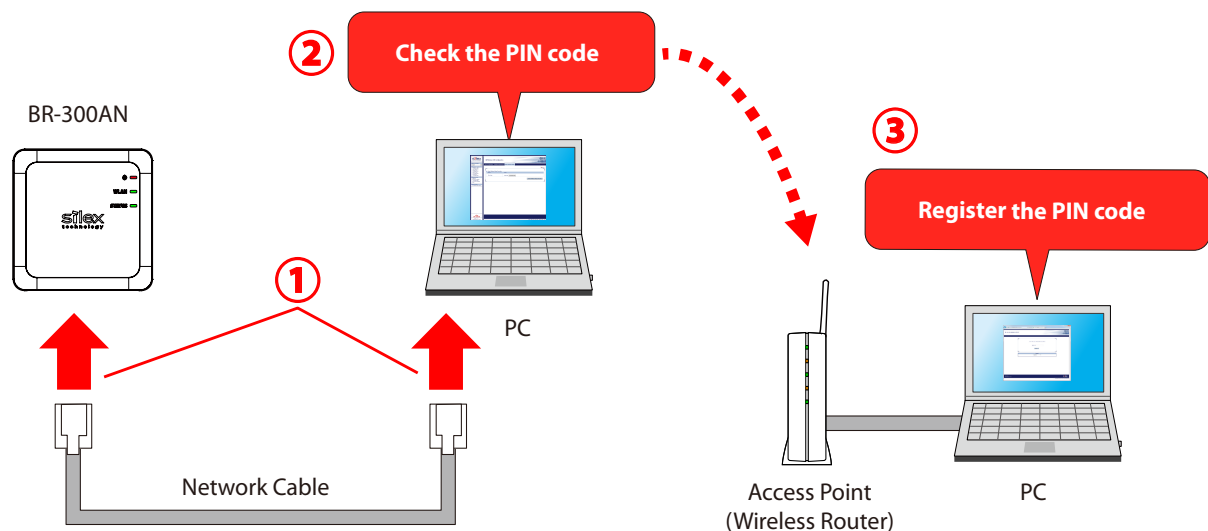

Note

- Two PCs are required for this configuration; one for the BR-300AN and the other one for your Access Point.

3-3. Necessary Wireless Setting Information

When you configure BR-300AN using the Configuration Mode, the wireless settings need to be configured appropriately for your environment. As the same wireless settings must be configured for both BR-300AN and your Access Point, you need to get the necessary setting information of your Access Point beforehand.



Note

- If you plan to configure the BR-300AN using Smart Wireless Setup, you will not have to get the wireless setting information.



TIP

- The wireless setting information explained in this page is specific to your network and cannot be provided by Silex technical support. For how to confirm each setting, please refer to the operation manual that came with your router or contact the manufacturer.
- Depending on your Access Point, WPS may need to be enabled manually. For details, refer to the operation manual that came with your Access Point.
- If a security feature such as MAC Address filtering is enabled on your Access Point, change the setting so that BR-300AN can communicate with your Access Point. For details, refer to the operation manual that came with your Access Point.
- For the IEEE802.1X authentication, refer to **5-2. IEEE802.1X Authentication**.

SSID	The SSID is an ID that distinguishes a wireless LAN network from others. For wireless devices to communicate with each other on a wireless network, they must share the same SSID. (The SSID is also referred to as "ESSID".) Depending on your Access Point, it may have several SSIDs. If there are different SSIDs for a game console and computer, use the one for the computer.	
Encryption Mode	No Encryption	Uses no encryption for wireless communication. (In this case, you do not have to get any of your settings beforehand.)
	WEP	If WEP encryption is used, wireless communication will be encrypted using the settings for "WEP Key 1-4" and "Key Index". Set the same "WEP Key Size(64bit/128bit)", "WEP Key" and "Key Index" as the wireless device you wish to connect.
	WPA / WPA2	Uses PSK for network authentication. The encryption key will be generated by communicating with the Access Point using a Pre-Shared key. WEP key setting is not used for this mode. Set the same "Pre-Shared key" and "Encryption Mode"(AES/AUTO) as the wireless device you wish to connect. The Pre-Shared key is also referred to as "Network Key" or "Password".

4. How to Configure BR-300AN

This chapter explains how to configure BR-300AN.

Following configuration methods are available:

- 1) Configuration using Configuration Mode
- 2) Configuration using Smart Wireless Setup (Push Switch)
- 3) Configuration using Smart Wireless Setup (PIN code)



- For details on each configuration method, refer to **3-2. Configuration Method**.

Note

4-1. Easy Configuration Using Configuration Mode

How to configure BR-300AN using the Configuration Mode is explained.

Starting BR-300AN in Configuration Mode

1. Connect BR-300AN and the PC (to use for setup) using a network cable.

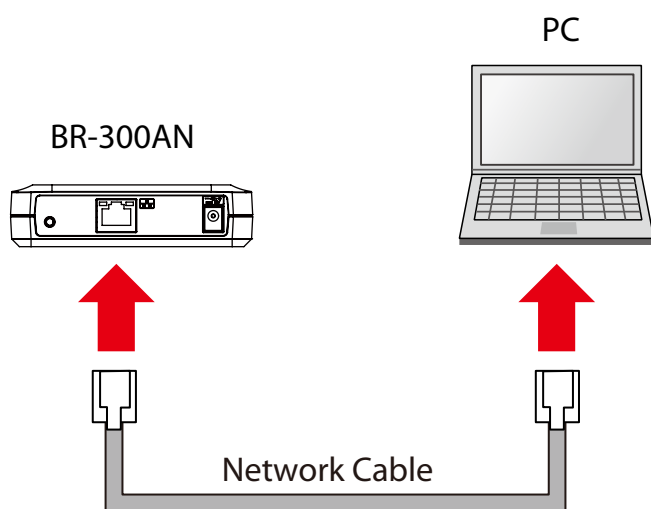

2. Connect the AC adaptor to BR-300AN, and the AC adaptor's plug to an electrical outlet.

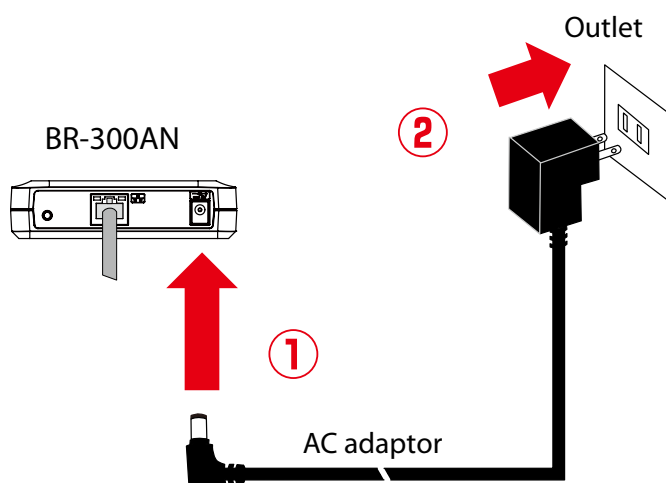

- 3.** When the POWER LED on top of BR-300AN turns Red, press and hold the push switch on the front. Release the push switch when the WLAN LED and STATUS LED start blinking Green together (it may take 20sec until blinking). BR-300AN will start operating in the Configuration Mode and you will be ready to configure BR-300AN from the PC.

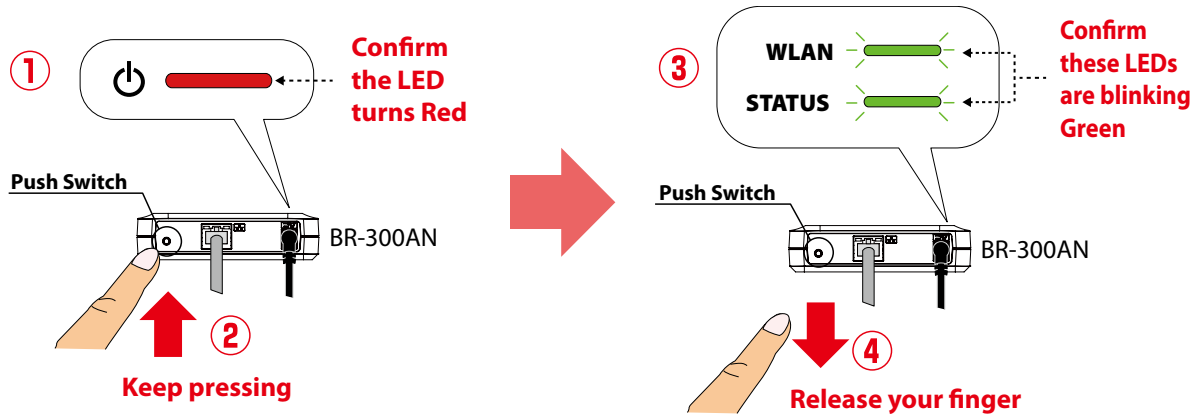

Configuration

1. Start a Web browser (Internet Explorer, Safari, etc) on the PC you are using for the setup. The Web page of BR-300AN is displayed.

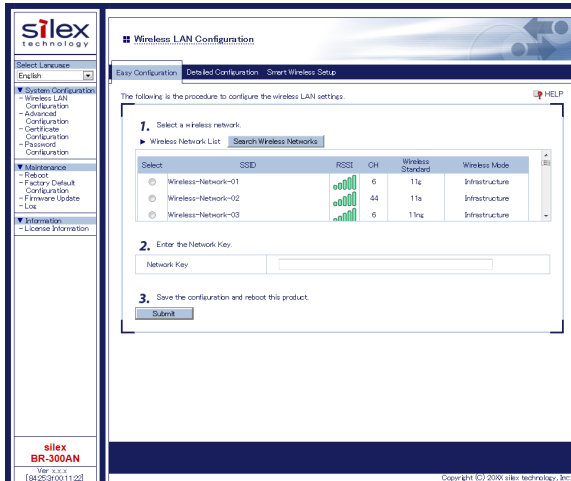

Note

- If the Web page is not displayed, enter "**http://silex**" in the address bar of the Web browser and press the Enter key.

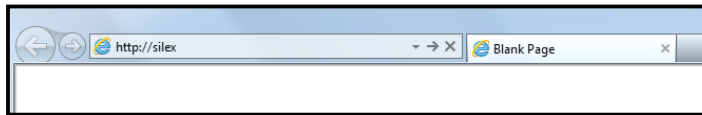

- If a password is set to BR-300AN, the password entry screen is displayed. Enter the password and click **Login**.
- By defaults, the password entry screen is not displayed. Go on to **2** then.

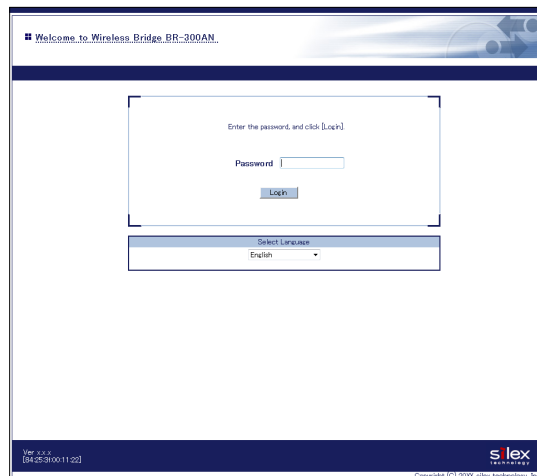

**TIP**

- To start the configuration, the PC and BR-300AN need to communicate each other properly.
- Confirm that an IP Address is correctly configured to the PC.
- If a wireless LAN is enabled on your PC, please disable it.
- If a static IP address is set to the PC, the Web configuration interface cannot be displayed in the following cases:
 - An IP address of the different segment is entered to the address bar, when the default gateway address is not configured to the PC.
 - A URL ("www.silxtechnology.com", etc.) is entered to the address bar when the name resolution is disabled (DNS server address is not registered or NetBIOS is disabled).

- 2.** In the Web configuration interface, select the Access Point from the **Wireless Network List** and enter the WEP key or Shared Key for the **Network Key**. Click **Submit** when finished.

The following is the procedure to configure the wireless LAN settings. HELP

- Select a wireless network.
 - Wireless Network List

Select	SSID	RSSI	CH	Wireless Standard	Wireless Mode
<input checked="" type="radio"/>	Wireless-Network-01		6	11g	Infrastructure
<input type="radio"/>	Wireless-Network-02		44	11a	Infrastructure
<input type="radio"/>	Wireless-Network-03		6	11ng	Infrastructure
- Enter the Network Key.
 - Network Key:
- Save the configuration and reboot this product.
 -

**Note**

- For network key, usable characters will differ depending on the AP to connect.
- For WEP key, enter 5 or 13 characters or 10 or 26 digit hexadecimal value. For details, refer to **WEP Key 1-4** at **A-1. List of All Settings**.
- For Pre-Shared key, enter 8-63 characters or 64 hexadecimal value. For details, refer to **Pre-Shared Key** at **A-1. List of All Settings**.

- To connect multiple network devices using an Ethernet HUB, click **Advanced Configuration** and select **Multi-Client Mode** for **Client Mode**.

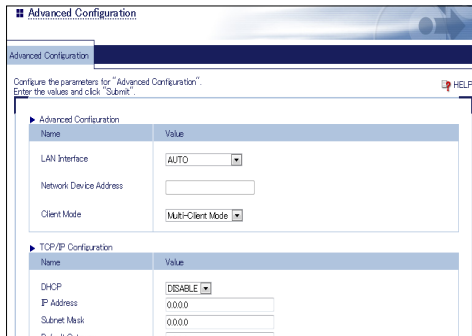

- If the Access Point is operating in a stealth mode, it is not displayed at **Wireless Network List**. In such a case, click **Detailed Configuration** on the top, enter the detailed setting information of the Access Point and click **Submit**. For details on each setting, please refer to the HELP on Web configuration interface.
- To use the IEEE802.1X authentication, click the **Detailed Configuration** on the top, enter the detailed setting information of the Access Point and click **Submit**. For details on each setting, please refer to the HELP on Web configuration interface.
- Up to 32 Access Points can be displayed at **Wireless Network List**.
- If the Access Point you wish to connect is not displayed in the list, you may have reached the maximum number of wireless devices that BR-300AN can detect and show in the list. In that case, use the SSID filter to display the necessary Access Point only.
To use the SSID filter, click the **Detailed Configuration** on the top, enter the SSID of the Access Point you wish to connect, select **ON** at **SSID Filter** and click **Submit**. The SSID filter will become active after the PC is restarted.

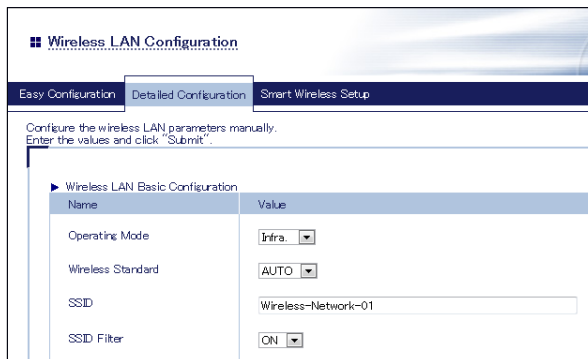

3. When the completion message is displayed on the Web configuration interface, finish the Web browser. The configuration has been completed.

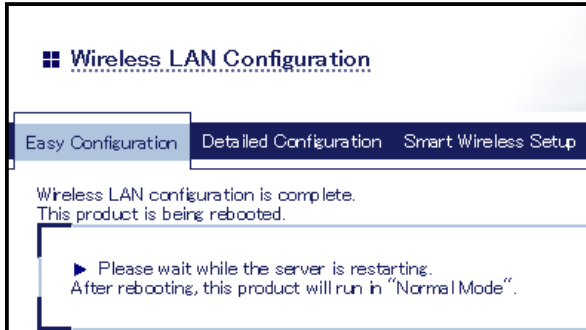

When you wish to bridge the PC used for this configuration wirelessly, restart the PC. To bridge another device wirelessly, turn off both BR-300AN and PC, remove the BR-300AN from the PC and connect the BR-300AN to the device you wish to use wirelessly using a network cable. For details, refer to **Connecting Non-wireless Devices** in the next page.

Connecting Non-wireless Devices

1. Turn off the non-wireless device that you wish to use wirelessly and connect the BR-300AN to it using a network cable. The connection method will vary depending on each operating mode.

How to Connect in Single Client Mode

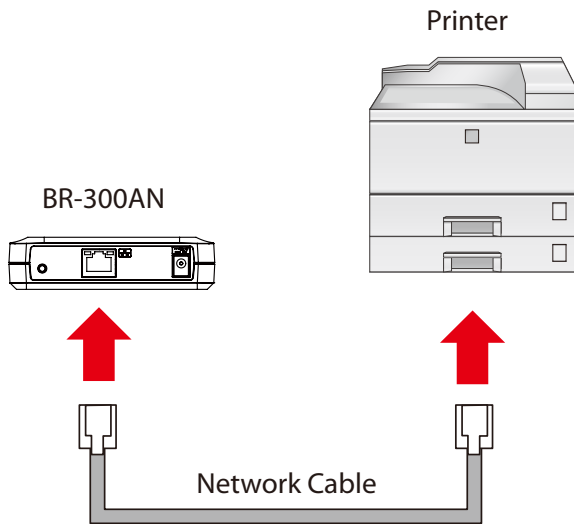

How to Connect in Multi-Client Mode

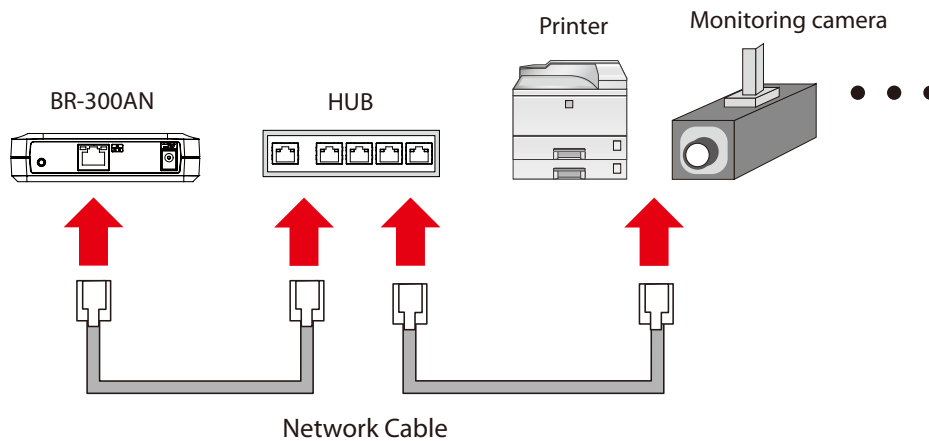

- For details on each operating mode, refer to **3.1 Operating Mode**.

Note

2. Connect the AC adaptor to the BR-300AN and the AC plug to the outlet.

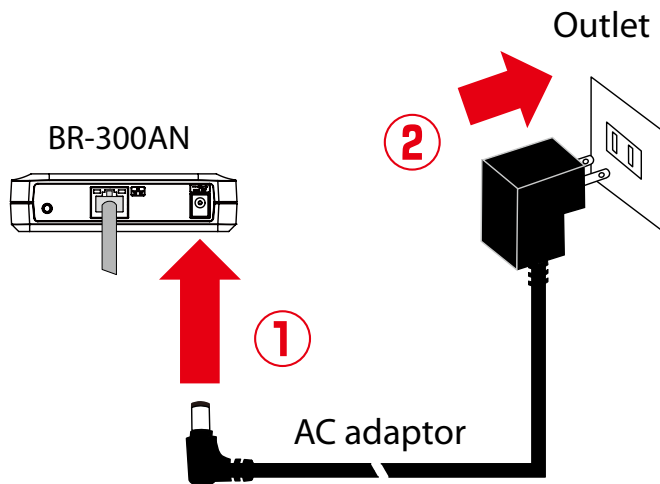

3. Turn on the non-wireless device connected to the BR-300AN.
During the MAC address resolution, the WLAN LED and STATUS LED will flash Green alternately. When the LED status has changed from it, the BR-300AN will be ready to use. You can use the non-wireless device over a wireless network.

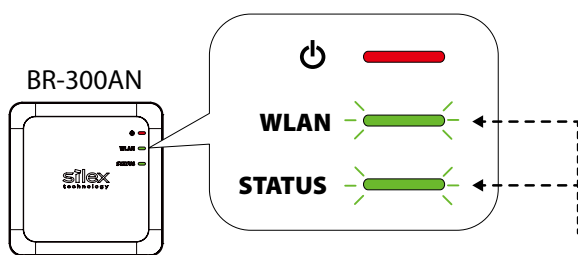

The LEDs flash Green alternately during the MAC address resolution



Note

- Depending on the non-wireless device you have connected, further network settings may need to be configured to that device. In such a case, please configure it according to the operating manual that came with your device.
- When you turn on the BR-300AN and your non-wireless device, be sure to turn on the BR-300AN first. Do not press the push switch then.

4-2. Configuration Using Smart Wireless Setup (Push Switch)

The wireless settings can be configured easily using the push switch if your Access Point supports WPS(Wi-Fi Protected Setup). How to configure the wireless settings using the push switch is explained below.



- Please check that the Access Point supporting WPS is installed on your network.
- This configuration method is not available if the Access Point is operating in a stealth mode.
- To ensure proper communication during this configuration, please temporarily move the BR-300AN closer to the Access Point.
- The WPS feature may need to be enabled on your Access Point manually. For details, see the operating manual that came with your Access Point.
- If a security feature such as MAC address filtering is enabled on your Access Point, disable it temporarily.
- If the SSID filter is enabled on the BR-300AN, this configuration method cannot be used. To disable the SSID filter, turn on the BR-300AN in Configuration Mode and change the setting, or otherwise, initialize the BR-300AN.
- To connect multiple devices using a HUB, use **Multi-Client Mode**. See **5-1. How to Access Web Configuration Interface** to change the operating mode.

Configuration

When the operating mode is **Single Client Mode**, you need to connect a non-wireless device to the BR-300AN in order to start the configuration.

When the operating mode is **Multi-Client Mode**, you do not have to connect a non-wireless device. In such a case, start from **2** in this section.

**Note**

- By default, the operating mode is set to **Single Client Mode**.
- To see which operating mode your BR-300AN is running on, start the BR-300AN in the Configuration Mode and access the Web page.

1. Turn off the non-wireless device that you wish to use wirelessly and connect the BR-300AN to it using a network cable.

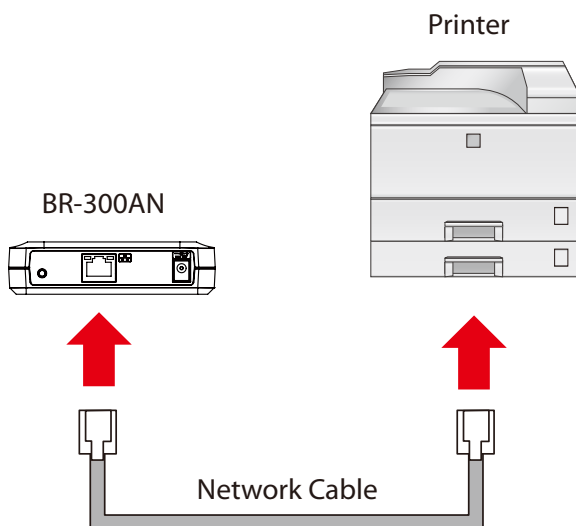

2. Connect the AC adaptor to the BR-300AN and the AC plug to the outlet.

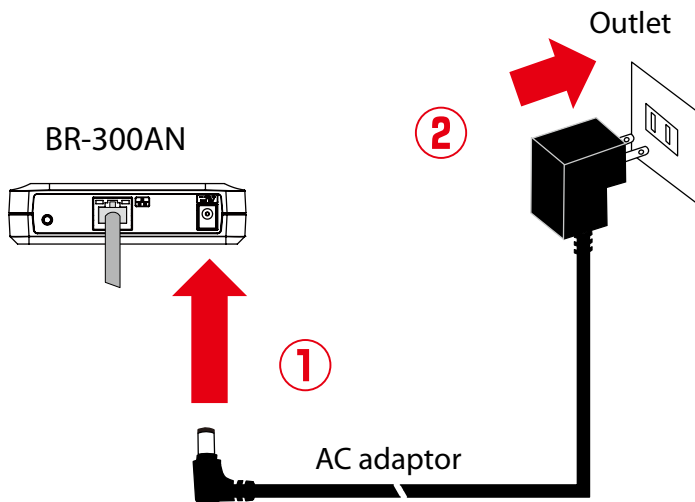

3. Turn on the non-wireless device connected to the BR-300AN.

During the MAC address resolution, the WLAN LED and STATUS LED will flash Green alternately. When the LED status has changed from it, the BR-300AN will be ready to configure using Smart Wireless Setup.

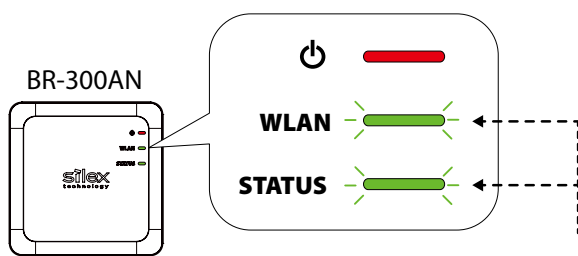

The LEDs flash Green alternately during the MAC address resolution



Note

- Depending on the non-wireless device you have connected, further network settings may need to be configured to that device. In such a case, please configure it according to the operating manual that came with your device.
- When you turn on the BR-300AN and your non-wireless device, be sure to turn on the BR-300AN first. Do not press the push switch then.

4. Press the WPS button on your Access Point.

Confirm that your Access Point is ready for a wireless connection to be made.

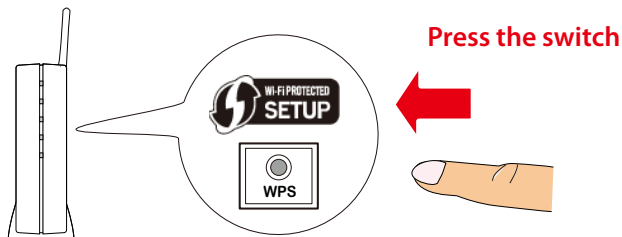

Access Point

**Note**

- The name, position and shape of the WPS button will differ depending on your Access Point. For details, refer to the operation manual that came with your Access Point.
- Please use only one Access Point. If two or more Access Points are waiting for wireless connections, BR-300AN will not be able to connect properly.

5. Press and hold the push switch on the BR-300AN. The WLAN LED and STATUS LED will start to blink Green together.

When the WLAN LED keeps blinking Green while STATUS LED turns off, release the push switch (it may take 15 sec until the STATUS LED turns off after the WLAN and STATUS LEDs blink together).

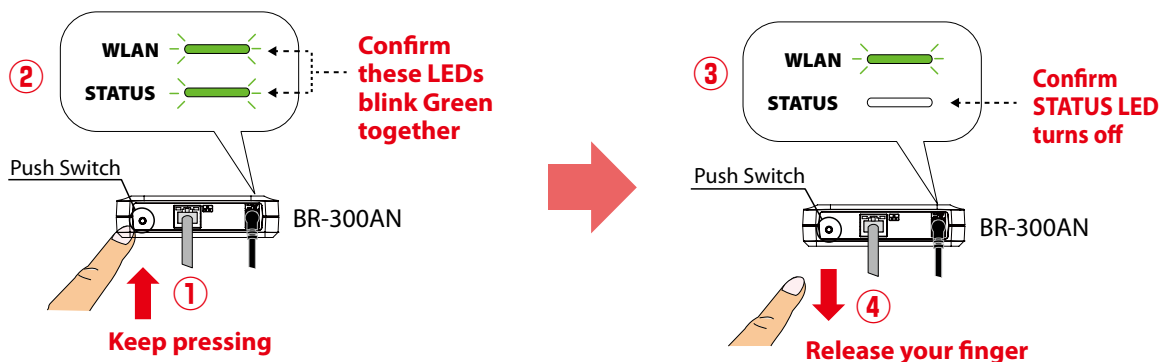

6. The BR-300AN and the Access Point will start to communicate each other. When the configuration finished successfully, the WLAN LED turns Green and the STATUS LED turns or blinks Green.

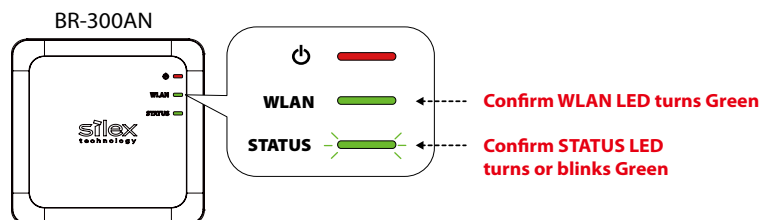
**Note**

- It may take up to 2 min to finish the wireless configuration depending on your environment.
 - If the wireless configuration is finished in failure, the WLAN LED will flash rapidly for 10 sec.
- In such a case, read the instructions carefully and start from **4** again.

If you plan to use BR-300AN in **Single Client Mode**, you can keep using the connected non-wireless device to use it wirelessly.

To replace it with the other non-wireless device, turn off the BR-300AN and replace the connected non-wireless device to it. See **Connecting Non-wireless Devices** in the next page for how to connect the BR-300AN and non-wireless device using a network cable.

To change the operating mode, start the BR-300AN in configuration mode. For details, refer to **5-1. How to Access Web Configuration Interface**.

Connecting Non-wireless Devices

1. Turn off the non-wireless device that you wish to use wirelessly and connect the BR-300AN to it using a network cable. The connection method will vary for each operating mode.

How to Connect in Single Client Mode

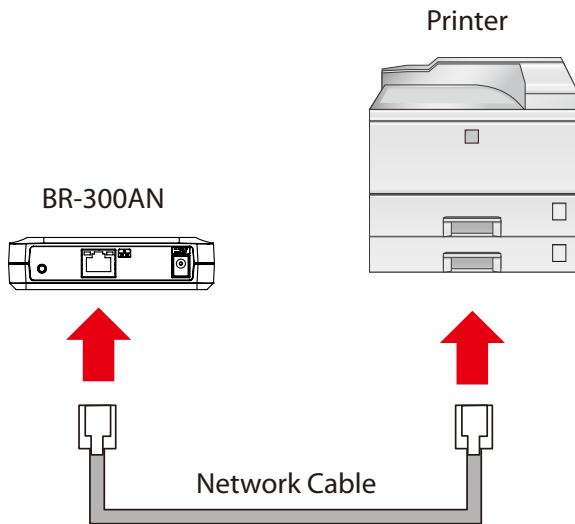

How to Connect in Multi-Client Mode

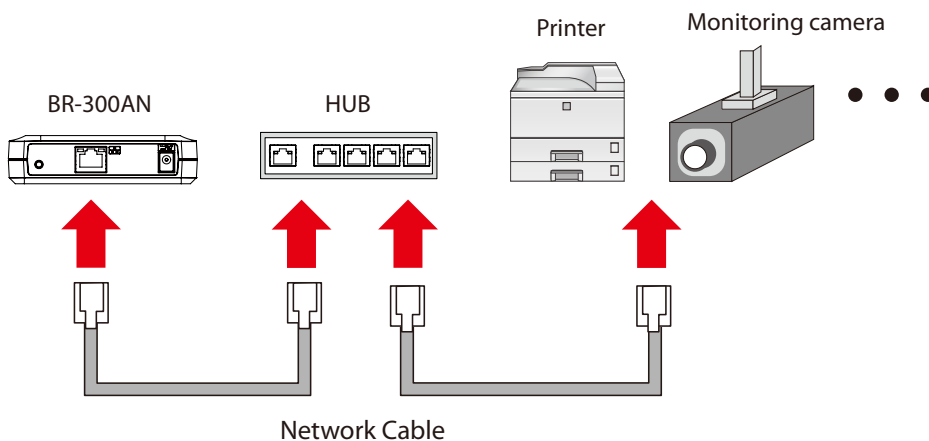

- For details on each operating mode, refer to **3.1 Operating Mode**.

Note

2. Connect the AC adaptor to the BR-300AN and the AC plug to the outlet.

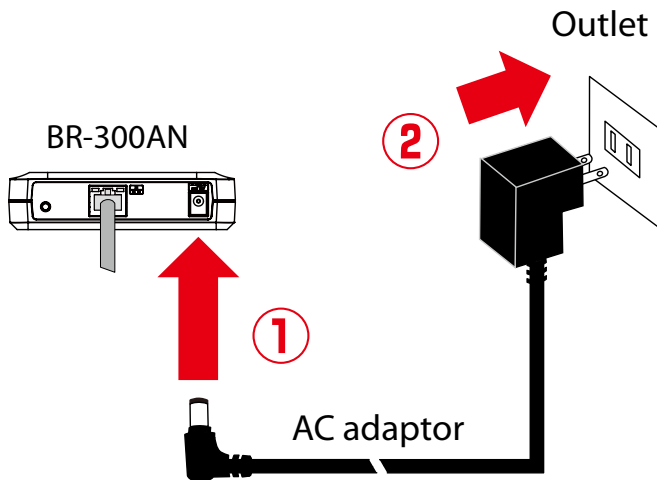

3. Turn on the non-wireless device connected to the BR-300AN.
During the MAC address resolution, the WLAN LED and STATUS LED will flash Green alternately. When the LED status has changed from it, the BR-300AN will be ready to use. You can use the non-wireless device over a wireless network.

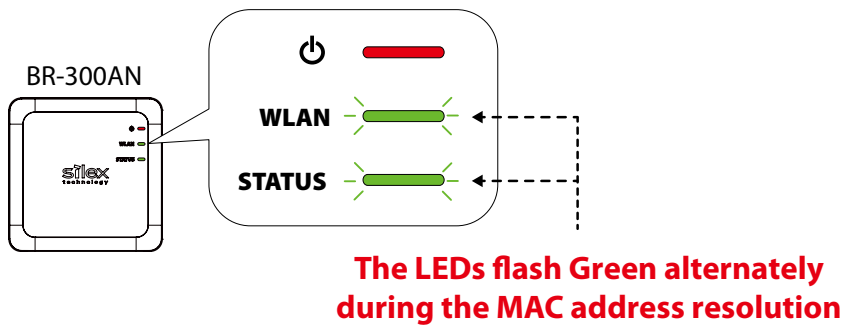

Note

- Depending on the non-wireless device you have connected, further network settings may need to be configured to that device. In such a case, please configure it according to the operating manual that came with your device.
- When you turn on the BR-300AN and your non-wireless device, be sure to turn on the BR-300AN first. Do not press the push switch then.

4-3. Configuration Using Smart Wireless Setup(Pin Code)

The wireless settings can be configured easily using the PIN code when your Access Point supports WPS(Wi-Fi Protected Setup). How to configure the wireless settings using the PIN code is explained below.



- Please check that the Access Point supporting WPS is installed on your network.
- This configuration method is not available if the Access Point is operating in a stealth mode.
- To ensure proper communication during this configuration, please temporarily move the BR-300AN closer to the Access Point.
- The WPS feature may need to be enabled on your Access Point manually. For details, see the operating manual that came with your Access Point.
- If a security feature such as MAC address filtering is enabled on your Access Point, disable it temporarily.
- If the SSID filter is enabled on the BR-300AN, this configuration method cannot be used. To disable the SSID filter, turn on the BR-300AN in Configuration Mode and change the setting, or otherwise, initialize the BR-300AN.
- To connect multiple devices using a HUB, use **Multi-Client Mode**. See **5-1. How to Access Web Configuration Interface** to change the operating mode.

Starting BR-300AN in Configuration Mode

1. Connect BR-300AN and the PC (to use for setup) using a network cable.

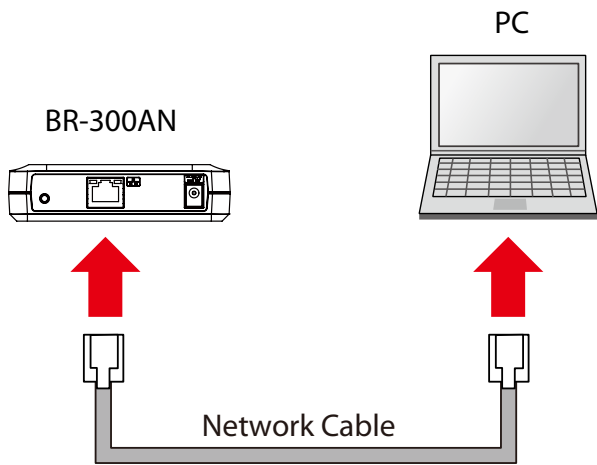

2. Connect the AC adaptor to BR-300AN, and the AC adaptor's plug to an electrical outlet.

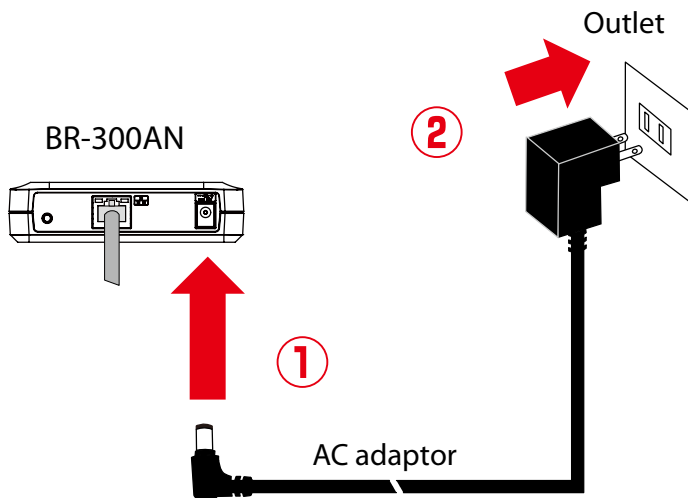

3. When the POWER LED on top of BR-300AN turns Red, press and hold the push switch on the front. Release the push switch when the WLAN LED and STATUS LED start blinking Green together (it may take 20sec until blinking). BR-300AN will start operating in the Configuration Mode and you will be ready to configure BR-300AN from the PC.

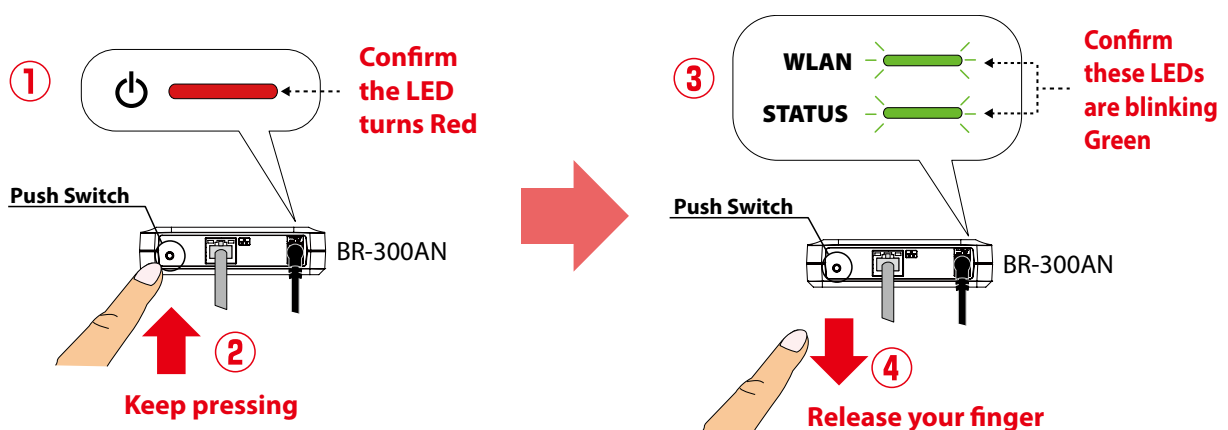

Checking a PIN Code

1. Start a Web browser (Internet Explorer, Safari, etc) on the PC you are using for the setup. The Web page of BR-300AN is displayed.

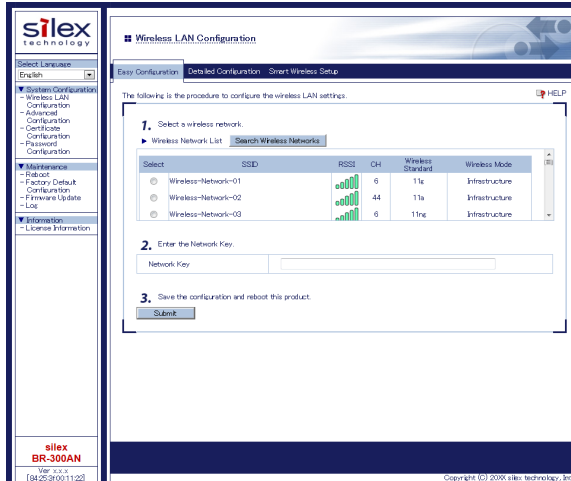

Note

- If the Web page is not displayed, enter "**http://silex**" in the address bar of the Web browser and press the Enter key.

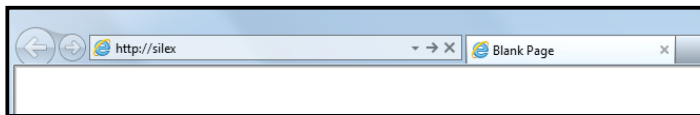

- If a password is set to BR-300AN, a password entry screen is displayed. Enter the password and click **Login**.
- The password entry screen is not displayed at the initial setup. Go on to **2** then.

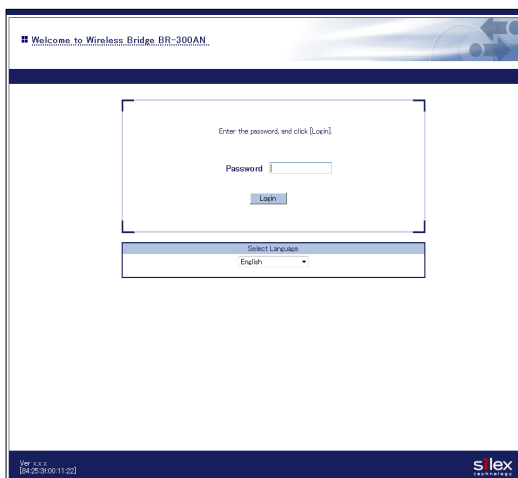

**TIP**

- To start the configuration, the PC and BR-300AN need to communicate each other properly.
- Confirm that an IP Address is correctly configured to the PC.
- If a wireless LAN is enabled on your PC, please disable it.
- If a static IP address is set to the PC, the Web configuration interface cannot be displayed in the following cases:
 - An IP address of the different segment is entered to the address bar, when the default gateway address is not configured to the PC.
 - A URL ("www.silextechnology.com", etc.) is entered to the address bar when the name resolution is disabled (DNS server address is not registered or NetBIOS is disabled).

2. In the Web configuration interface, click **Wireless LAN Configuration - Smart Wireless Setup** and check the PIN code. Keep this screen displayed as it will be used again at **Configuration** in the next page. Do not click the **Smart Wireless Setup Execution** button yet.

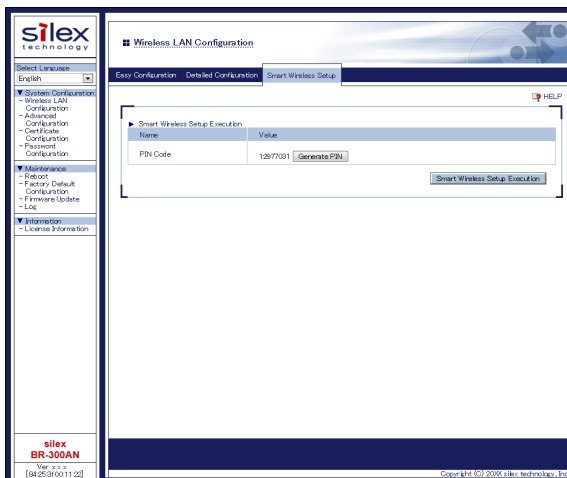
**TIP**

- Do not click the **Smart Wireless Setup Execution** button yet. It will need to be clicked at **Configuration** in the next page.

**Note**

- To change the PIN code, click the **Generate PIN** button. A new PIN code will be generated automatically.

Configuration

1. Access the Web configuration interface of the Access Point using a Web browser (Internet Explorer, Safari, etc) on your PC. Enter the PIN code and start the WPS connection from the Access Point.

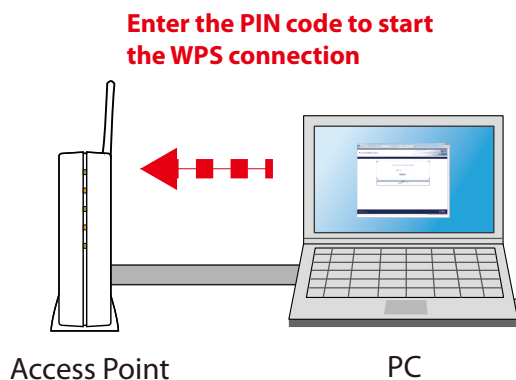

Note

- The method to enter the PIN code on Access Point will differ depending on each Access Point. For details, refer to the operating manual that came with your Access Point.

2. Go back to the **Smart Wireless Setup** page of the BR-300AN and click the **Smart Wireless Setup Execution** button.

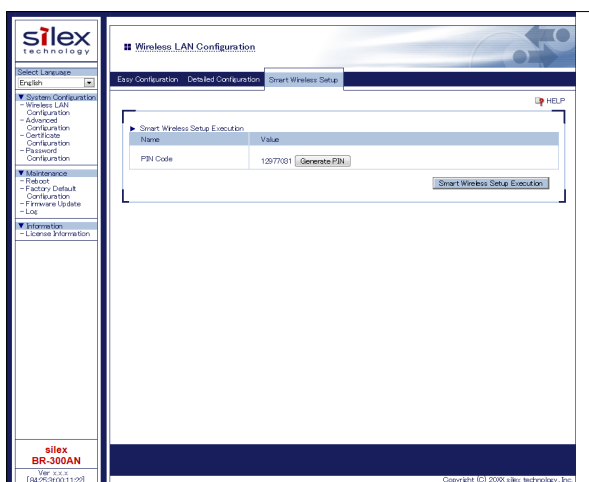

TIP

- If Smart Wireless Setup is started on the BR-300AN earlier than the Access Point, the configuration may fail.

- 3.** The BR-300AN and the Access Point will start to communicate each other.
The wireless configuration is successfully completed when the WLAN LED turns Green and the STATUS LED turns or blinks Green.

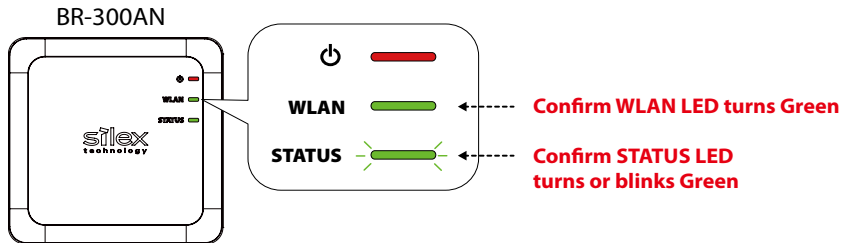

Note

- It may take up to 2 min to finish the wireless configuration depending on your environment.
- If the wireless configuration failed, the WLAN LED will flash rapidly for 10 sec. In such a case, read the **TIP** at the beginning of **4-3. Configuration Using Smart Wireless Setup(Pin Code)** and try again.
- To change the PIN code, see **Checking a PIN Code**.

If you plan to use the PC wirelessly (the one you have been using for this configuration), restart the PC. To use the other non-wireless device wirelessly, turn off the BR-300AN and the PC, and connect the BR-300AN to the non-wireless device using a network cable.

For details, refer to **Connecting Non-wireless Devices** in the next page.

Connecting Non-wireless Devices

1. Turn off the non-wireless device that you wish to use wirelessly and connect the BR-300AN to it using a network cable. The connection method will vary for each operating mode.

How to Connect in Single Client Mode

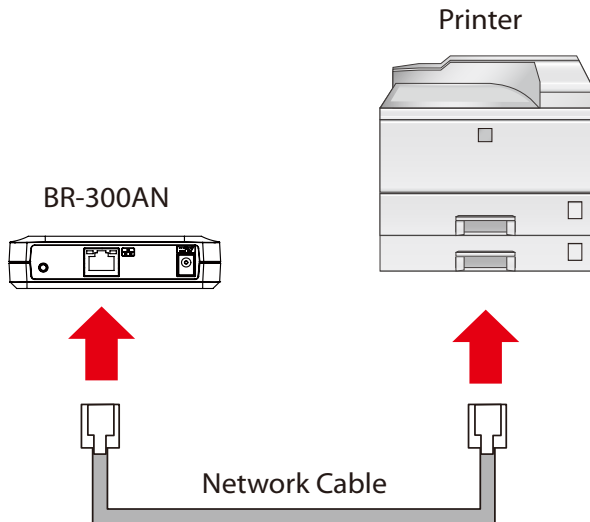

How to Connect in Multi-Client Mode

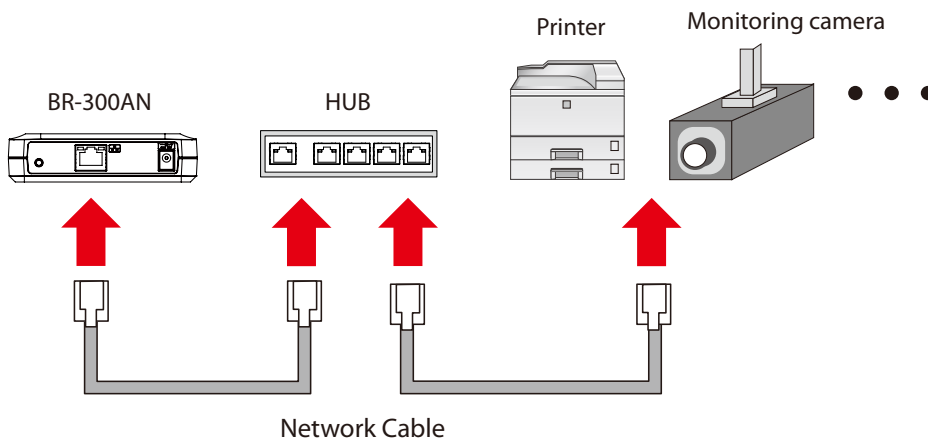

- For details on each operating mode, refer to **3.1 Operating Mode**.

Note

2. Connect the AC adaptor to the BR-300AN and the AC plug to the outlet.

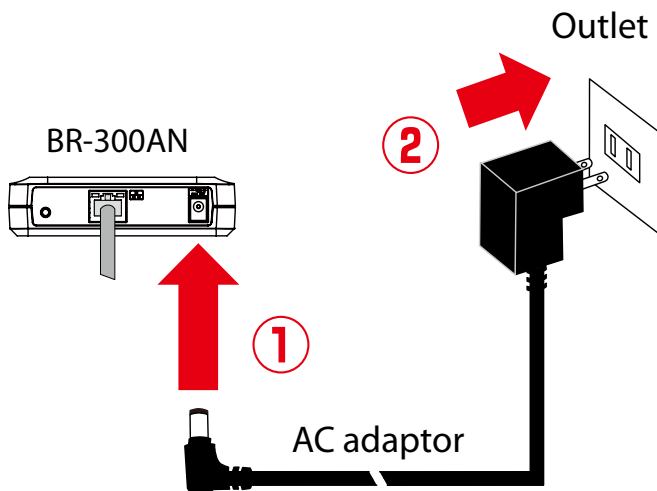

3. Turn on the non-wireless device connected to the BR-300AN.
During the MAC address resolution, the WLAN LED and STATUS LED will flash Green alternately. When the LED status has changed from it, the BR-300AN will be ready to use. You can use the non-wireless device over a wireless network.

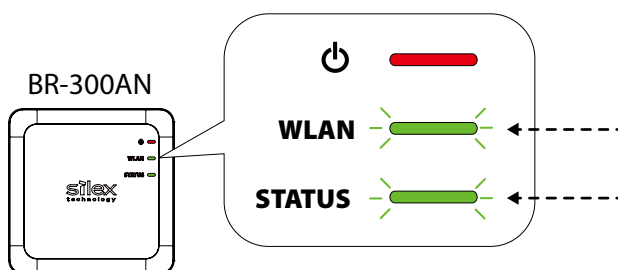

The LEDs flash Green alternately during the MAC address resolution



Note

- Depending on the non-wireless device you have connected, further network settings may need to be configured to that device. In such a case, please configure it according to the operating manual that came with your device.
- When you turn on the BR-300AN and your non-wireless device, be sure to turn on the BR-300AN first. Do not press the push switch then.

5. List of Functions

This chapter explains the BR-300AN functions.

5-1. How to Access Web Configuration Interface

The Configuration Mode is used when you access the Web configuration interface of BR-300AN. In the Web configuration interface, each setting can be configured.

How to start the BR-300AN in Configuration Mode as well as access the Web configuration interface are explained.

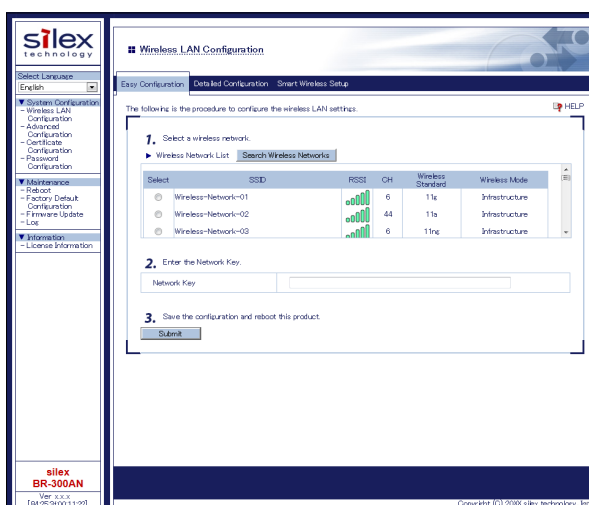

Starting BR-300AN in Configuration Mode

1. Connect BR-300AN and the PC (to use for setup) using a network cable.

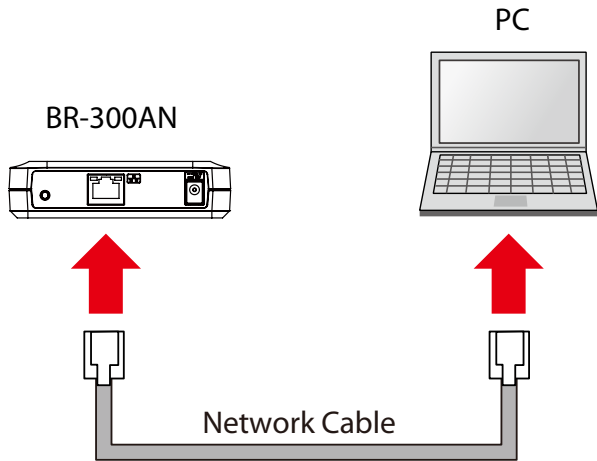

- To start the configuration, the PC and BR-300AN need to communicate each other properly.
- Confirm that an IP Address is correctly configured to the PC.
- If a wireless LAN is enabled on your PC, please disable it.

2. Connect the AC adaptor to BR-300AN, and the AC adaptor's plug to an electrical outlet.

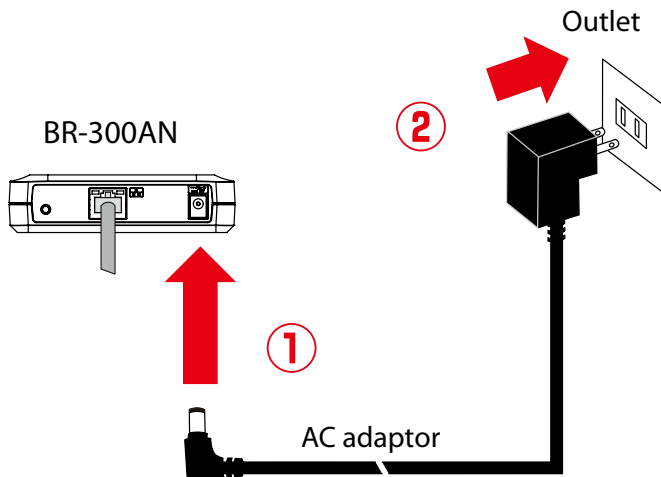

- 3.** When the POWER LED on top of BR-300AN turns Red, press and hold the push switch on the front. Release the push switch when the WLAN LED and STATUS LED start blinking Green together (it may take 20sec until blinking). BR-300AN will start operating in the Configuration Mode and you will be ready to configure BR-300AN from the PC.

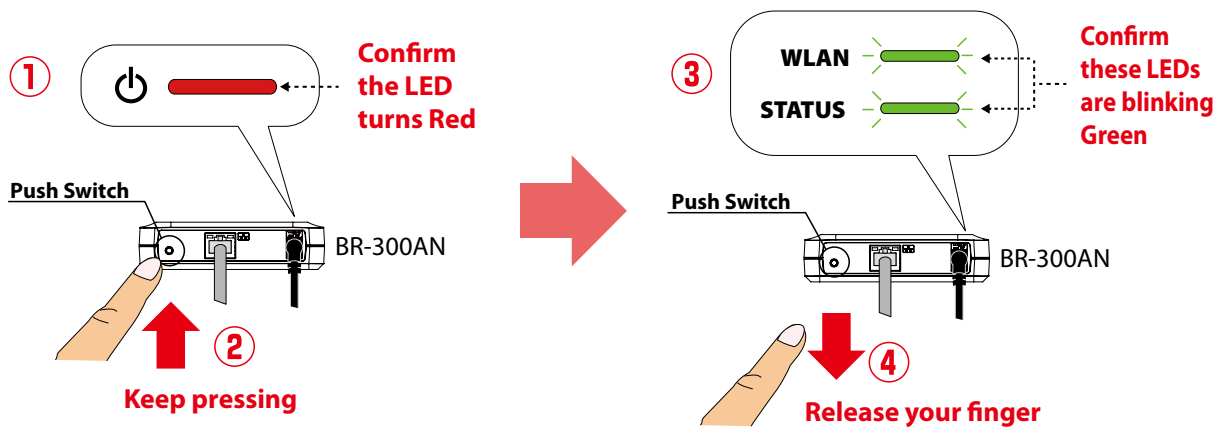

Configuration via Web Configuration Interface

Start a Web browser (Internet Explorer, Safari, etc) on the PC you are using for the setup. The Web configuration interface of BR-300AN is displayed. In the Web configuration interface, the operating mode, wireless setting, etc. can be changed.

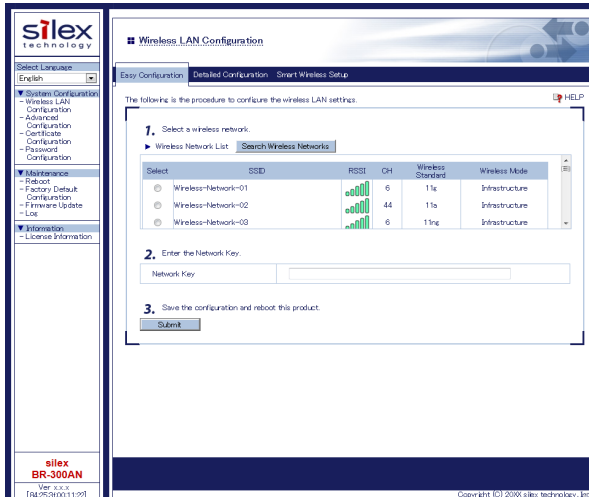

Note

- If the Web page is not displayed, enter "**http://silex**" in the address bar of the Web browser and press the Enter key.



- If a password is set to BR-300AN, the password entry screen is displayed. Enter the password and click **Login**. By defaults, the password entry screen is not displayed.



- BR-300AN needs to be restarted for changes to take effect.

5-2. IEEE802.1X Authentication

BR-300AN supports the IEEE802.1X authentication.

To use the IEEE802.1X authentication, a RADIUS server is needed.

Network Configuration

Connect the BR-300AN to a network as below when you use the IEEE802.1X authentication. The RADIUS server identifies the reliability of BR-300AN as an authentication host, while BR-300AN identifies the reliability of RADIUS server as an authentication client to identify the reliability of the network to connect to.

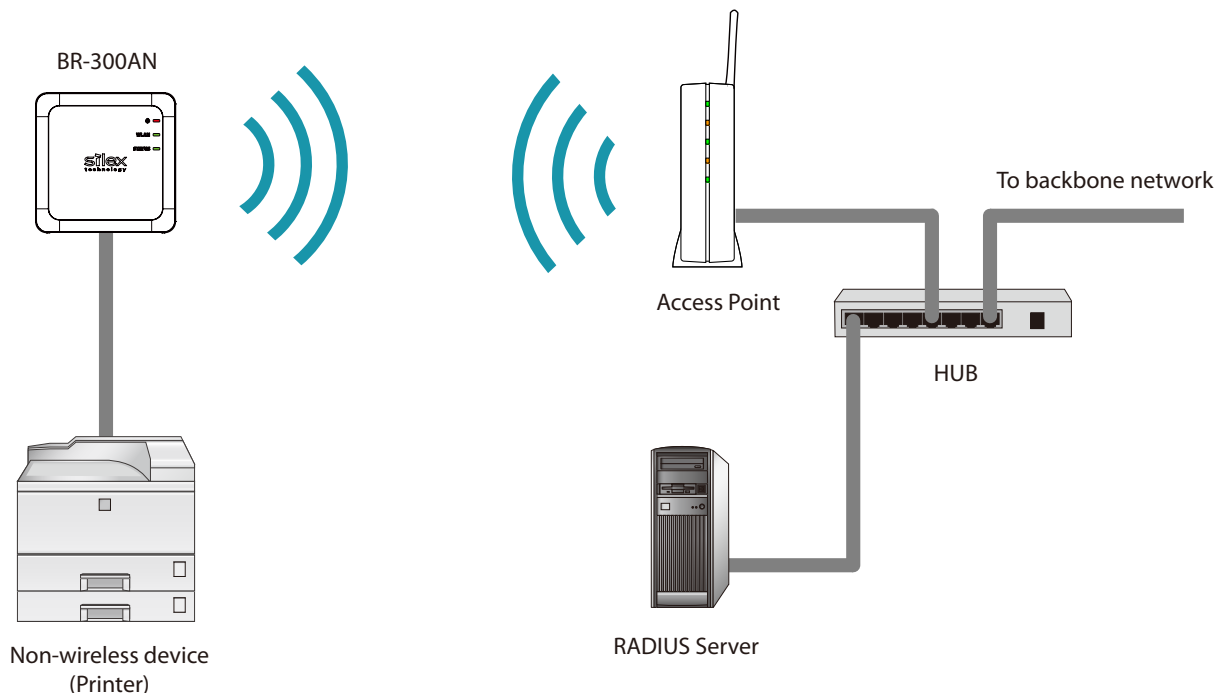

When using the authentication method that requires a certificate, get the necessary certificate issued by the certificate authority and import it to the BR-300AN.

To use this function, register the MAC address of non-wireless device with BR-300AN. The reliability of non-wireless devices connected to BR-300AN is identified using the MAC address filtering.



- IEEE802.1X authentication is supported only for wireless network.

TIP

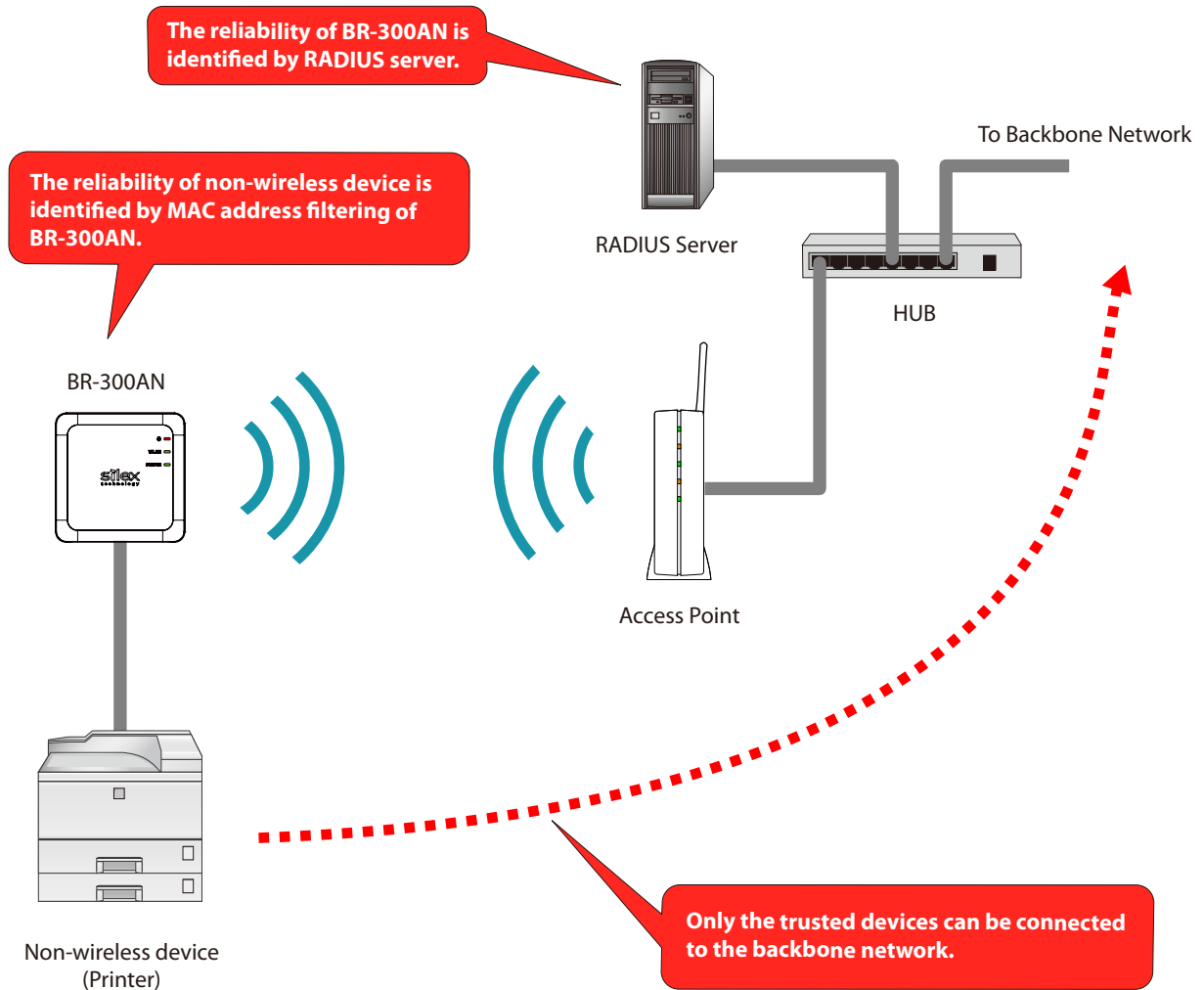

IEEE802.1X Authentication

BR-300AN supports the following IEEE802.1X authentication methods.

In the Web configuration interface of BR-300AN, select **ON** at **IEEE802.1X Authentication** and select the authentication mode at **IEEE802.1X Authentication Type**.

IEEE802.1X Authentication mode
EAP-TLS
EAP-TTLS
PEAP
EAP-FAST
LEAP

Settings on each authentication mode

The compatible settings on each authentication mode are as follows.

For details, refer to **Appendix A-1. List of All Settings**.

Name	IEEE802.1X Authentication Mode				
	EAP-TLS	EAP-TTLS	PEAP	EAP-FAST	LEAP
IEEE802.1X User Name	Necessary	Necessary	Necessary	Necessary	Necessary
Password	-	Necessary	Necessary	Necessary	Necessary
Inner Authentication Method	-	Necessary	Necessary	-	-
Server Certificate Verification	-	Optional	Optional	-	-
CA Certificate	Necessary	Optional	Optional	-	-
PAC Auto-distribution	-	-	-	Optional	-
PAC File	-	-	-	Optional	-
Password	-	-	-	Optional	-
Client Certificate	Necessary	-	-	-	-
Password	Necessary	-	-	-	-

Name	Details
IEEE802.1X User Name	This is an ID and password for the RADIUS server to identify the client.
Password	
Inner Authentication Method	Specify the authentication protocol to use. For PEAP, MSCHAPv2 is used.
Server Certificate Verification	Enable/Disable the reliability check of the RADIUS server. When ON is selected, CA certificate is required to verify the server certificate.
CA Certificate	This is a CA certificate to authenticate the RADIUS server.
PAC Auto-distribution	Enable/Disable the automatic PAC distribution. When OFF is selected, the PAC file generated by the RADIUS server is required.
PAC File	This is the file used for manual provisioning. This file is generated by the RADIUS server. To analyze a password-set PAC file, you need the password.
Password	
Client Certificate	Use this to check the client reliability. To read out the secret key from the client certificate, a password is required.
Password	

Certificate Standard

When using the authentication mode which uses a certificate, get the necessary certificate issued from the certificate authority and import it to the BR-300AN.

The BR-300AN supports the following certificates:

Certificate Standard

The certificate supports the standards as follows:

Certificate	Item	Compatible standards
Client certificate	X509 certificate version	v3
	Public key algorithm	RSA
	Public key size	512bit, 1024bit, 2048bit
	Signature algorithm	SHA1/SHA2(SHA-224,SHA-256,SHA-384,SHA-512) withRSA MD5withRSA
	X509v3 extended key usage	Client authentication (1.3.6.1.5.5.7.3.2)
CA certificate	Public key algorithm	RSA
	Public key size	512bit, 1024bit, 2048bit
	Signature algorithm	SHA1/SHA2(SHA-224,SHA-256,SHA-384,SHA-512) withRSA MD5withRSA

Certificate Saving Format

The following saving formats are supported:

Certificate	Compatible standards
Client certificate	PKCS#12, pfx * This is the format which includes a secret key of the certificate.
CA certificate for server authentication	DER (Binary encoded X509) PEM (A text form. DER is BASE64 encoded.)

MAC Address Filtering

When the IEEE802.1X authentication is used, access to the BR-300AN from non-wireless devices needs to be restricted so that access from unauthorized devices can be blocked. Check the MAC address of the non-wireless device you want to allow an access from and register it with the BR-300AN at **Network Device Address** of **IEEE802.1X Network Device Configuration** in the Web configuration interface.

Before Using the IEEE802.1X Authentication

In order to use the IEEE802.1X authentication on BR-300AN, the information below will be required.

(1) User name and password to access the RADIUS server

To access the RADIUS server, the user name and password are required. Also, when using the authentication method that requires a certificate, the certificate file will be needed.

(2) MAC address of the non-wireless device

BR-300AN allows bridging only for those with the registered MAC address. The MAC address information is required to allow them to be bridged using BR-300AN.

IEEE802.1X Authentication Settings

How to configure the IEEE802.1X authentication setting is explained.

To use the authentication method that requires a certificate, import the certificate file.

1. In the Web configuration interface of the BR-300AN, click **Wireless LAN Configuration - Detailed Configuration**.

In the **Detailed Configuration** page, enter the settings for the IEEE802.1X authentication and the MAC address of the non-wireless device you want to use wirelessly, and click **Submit**.

The screenshot shows the 'Wireless LAN Configuration' interface with the 'Detailed Configuration' tab selected. Key settings include:

- SSID Filter: OFF
- Network Authentication: WPA2
- IEEE802.1X Authentication: ON
- IEEE802.1X Authentication Configuration:
 - Name: (empty)
 - IEEE802.1X Authentication Type: EAP-TLS
- WPA/WPA2 Configuration:
 - Name: (empty)
 - Encryption Mode: AES
- IEEE802.1X User Configuration:
 - Name: (empty)
 - User Name in IEEE802.1X: user0123
- IEEE802.1X Network Device Configuration:
 - Name: (empty)
 - Device Filter: ON
 - Network Device Address: 84253F001122

* Settings will vary depending on the IEEE802.1X authentication mode you select.



TIP

- When the IEEE802.1X authentication is used, access to the BR-300AN from non-wireless devices needs to be restricted so that access from unauthorized devices can be blocked.
- The BR-300AN bridges only the devices whose MAC address is registered to **Network Device Address**. Check the MAC address of the non-wireless device to bridge and register it to **Network Device Address**.

IEEE802.1X Network Device Configuration	
Name	Value
Device Filter	ON
Network Device Address	84253F001122

- Please configure this even when you connect only one non-wireless device in a **Single Client Mode**.
- In **Multi-Client Mode**, register the MAC addresses of all non-wireless devices connected to the BR-300AN (up to 16 addresses).



Note

- When the MAC address is registered to **Network Device Address** of **Advanced Configuration** page, such setting will automatically take effect on this setting.
- The following MAC addresses cannot be used for this setting:
 - Broadcast address
 - Multicast address
 - The address composed of 12 zeros
 - Duplicated address (when operating in Multi-Client Mode)

2. The message below is displayed after the setting is updated.
When a certificate will be used for the selected authentication mode, click **OK**.
When not, click **Cancel** and go on to 5.

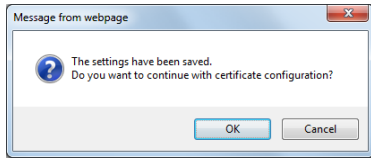

- If **Cancel** is clicked, the BR-300AN will be restarted.

Note

3. In the certificate configuration page, click **Browse** to specify the certificate file to use.
After the certificate file is specified, click **Submit**.

* The certificate will differ depending on the IEEE802.1X authentication mode you select.

Certificate to use	IEEE802.1X Authentication Method				
	EAP-TLS	EAP-TTLS	PEAP	EAP-FAST	LEAP
Client Certificate	Necessary	-	-	-	-
CA Certificate	Necessary	- (*1)	- (*1)	-	-
PAC File	-	-	-	- (*2)	-
Password	-	-	-	- (*2)	-

Note	<p>(*1) Necessary when the server certificate verification is ON. (*2) Necessary when the PAC file auto-distribution is OFF.</p>
------	--

4. After the certificate is registered, the message below is displayed. Click **Cancel**.

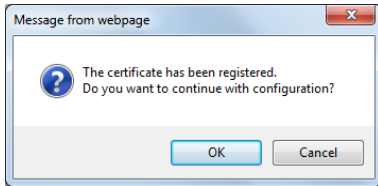

Note

- To continue the configuration, click **OK**. If **OK** is clicked, the BR-300AN will not be restarted.

5. The BR-300AN will be restarted and the IEEE802.1X authentication will take effect.

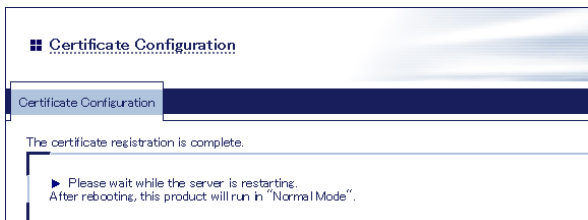

Turn off the BR-300AN and connect it to the non-wireless device using a network cable. Refer to **Connecting Non-wireless Devices** for details.

5-3. Saving Log

BR-300AN can save the operating log.

Once the log is saved, it can be retrieved or deleted from the Web configuration interface.

Types of Log

There are two types of log that can be saved by BR-300AN.

Details of each log are as follows.

System Log

Power-on status, operating status, etc. of BR-300AN are saved as a log file.

In case of a network trouble, you can check the operating status by referring the retrieved system logs. The system log can be retrieved or deleted from the **System Log** page of Web configuration interface.

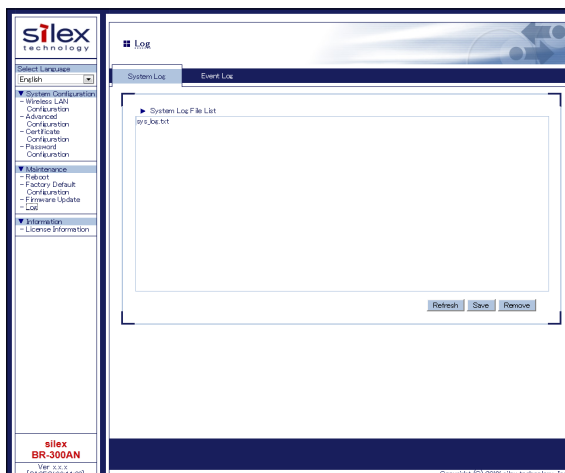



Note

- The system log file will remain even after BR-300AN is reset to factory defaults.
- When a size of log file (file name: **sys_log.txt**) exceeds 10MB, a new file is created. For the existing file, a number will be added to the end of the file name then.
- As the end number of the file name increases one by one when a new log file is created, files with a greater number will be older logs.
- Up to 99 log files can be saved, starting from **sys_log.txt.0** to **sys_log.txt.98**.
- If a new file is created when 99 log files have already been there, the oldest file **sys_log.txt.98** will be deleted.
- Up to 1GB log can be saved.

Event Log

When one of the following events occurs, the log message is saved.

- BR-300AN is connected to / disconnected from Access Point
- BR-300AN receives a specific packet from Access Point
- Smart Wireless Setup succeeded or failed

In case of a network trouble, you can check the wireless connection status by referring the retrieved event logs. The event log can be saved or viewed from the **Event Log** page of the Web configuration interface.

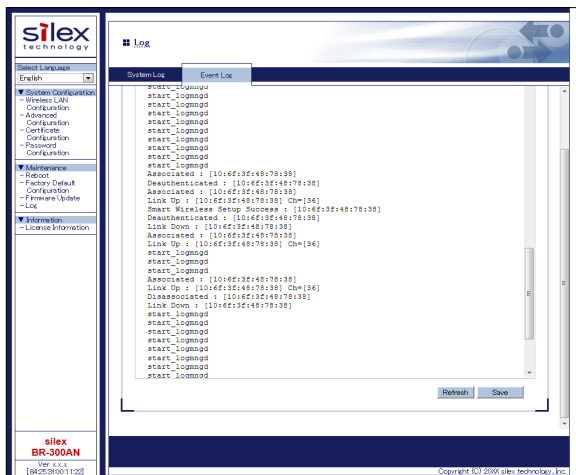

The event log file is saved as the format below:

Log	Events
start_logmngd	Event log saving is started.
Link up : [AP MAC Addr] : Ch=[channel]	Wireless connection is made to the Access Point of [AP MAC Addr] at a wireless channel of [channel].
Link Down : [AP MAC Addr]	Wireless connection is disconnected from the Access Point of [AP MAC Addr].
Deauthenticated : [AP MAC Addr]	Deauthenticated packet is received from the Access Point of [AP MAC Addr].
Associated : [AP MAC Addr]	Authentication finished successfully with the Access Point of [AP MAC Addr].
Disassociated : [AP MAC Addr]	Disassociated packet is received from the Access Point of [AP MAC Addr].
Smart Wireless Setup Success : [AP MAC Addr]	Smart Wireless Setup finished successfully with the Access Point of [AP MAC Addr].
Smart Wireless Setup Timeout	Smart Wireless Setup timeout
Smart Wireless Setup Overlapped	Smart Wireless Setup overlap
Smart Wireless Setup Failed	Smart Wireless Setup failed for a reason other than listed above.



Note

- Only one file is saved for event log.
- Up to 10MB log information can be saved as event log file. When it exceeds 10MB, the information will automatically be deleted from the older one.



TIP

- It is impossible to delete the event log file manually.

Retrieving/Deleting System Log

How to retrieve system log:

The system log saved on BR-300AN can be accessed from the Web configuration interface.

1. Connect BR-300AN and the PC using a network cable.

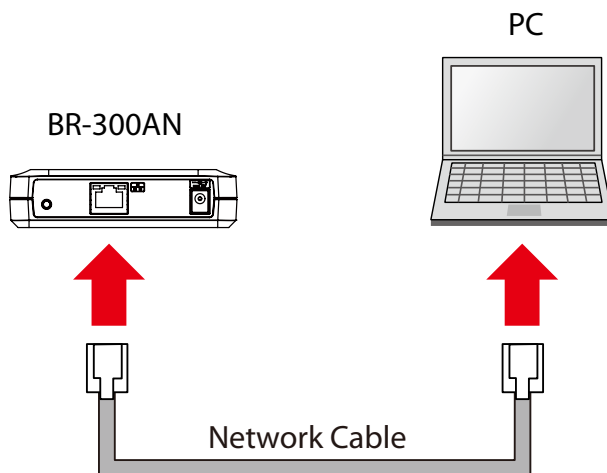

2. Connect the AC adaptor to BR-300AN, and the AC adaptor's plug to an electrical outlet.

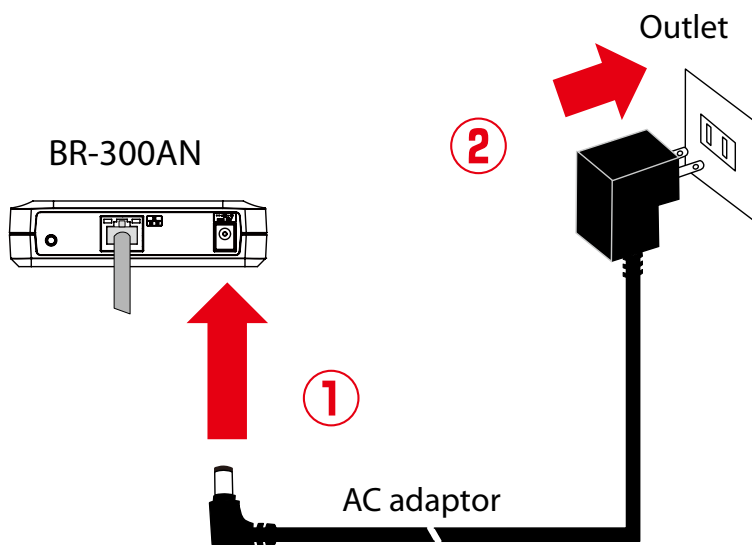

- When the POWER LED on top of BR-300AN turns Red, press and hold the push switch on the front. Release the push switch when the WLAN LED and STATUS LED start blinking Green together (it may take 20sec until blinking). BR-300AN will start operating in the Configuration Mode and you will be ready to configure BR-300AN from the PC.

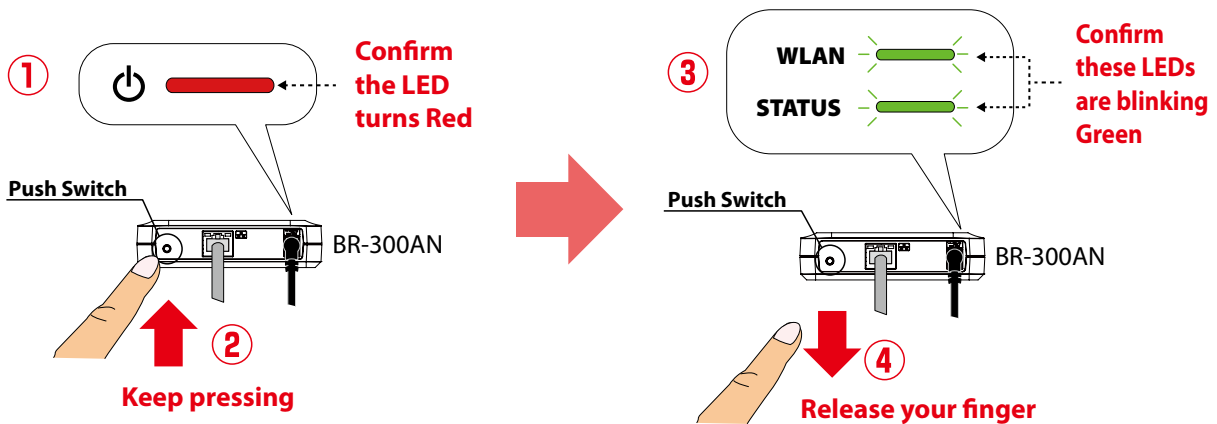

- Start a Web browser (Internet Explorer, Safari, etc) on the PC you are using for the setup. The Web page of BR-300AN is displayed.

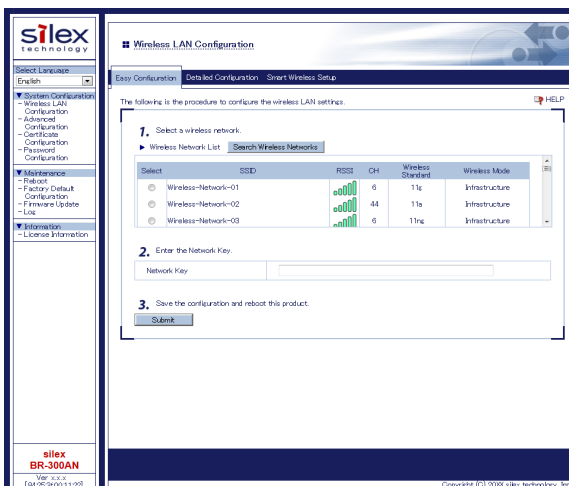

**Note**

- If the Web page is not displayed, enter "**http://silex**" in the address bar of the Web browser and press the Enter key.

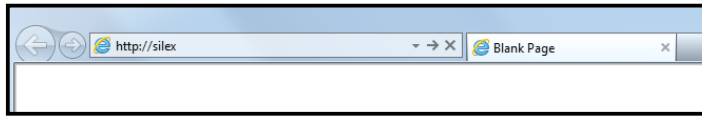

- If a password is set to BR-300AN, the password entry screen is displayed. Enter the password and click **Login**.
- By defaults, the password entry screen is not displayed. Go on to **5** then.

**TIP**

- To start the configuration, the PC and BR-300AN need to communicate each other properly.
- Confirm that an IP Address is correctly configured to the PC.
- If a wireless LAN is enabled on your PC, please disable it.
- If a static IP address is set to the PC, the Web configuration interface cannot be displayed in the following cases:
 - An IP address of the different segment is entered to the address bar, when the default gateway address is not configured to the PC.
 - A URL ("www.silextechnology.com", etc.) is entered to the address bar when the name resolution is disabled (DNS server address is not registered or NetBIOS is disabled).

5. Select **Log** to show a list of the system logs and click **Save** to save them.

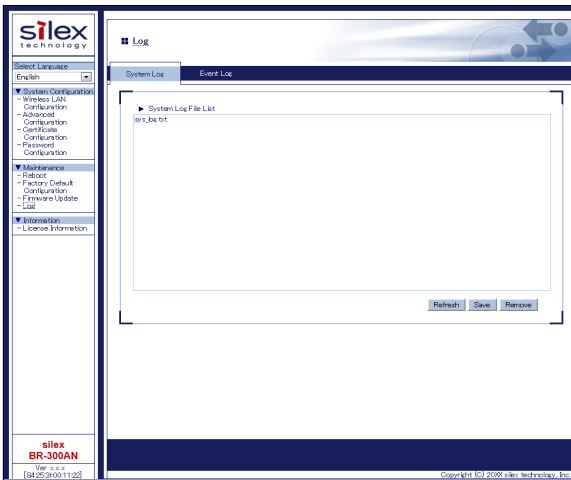

• The log files cannot be saved individually.

TIP

6. When the message appears to confirm where to save the compressed file of system logs (**sys_log_archive.tgz**), click **Save**.



- If ▼ is clicked, **Save as** option can be selected.

Note

The system log has been saved.

How to delete system log:

The system log saved on BR-300AN can be deleted from the Web configuration interface.

1. Connect BR-300AN and the PC using a network cable.

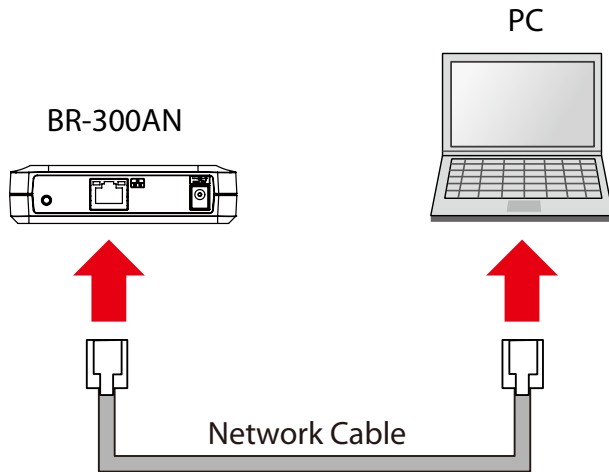

2. Connect the AC adaptor to BR-300AN, and the AC adaptor's plug to an electrical outlet.

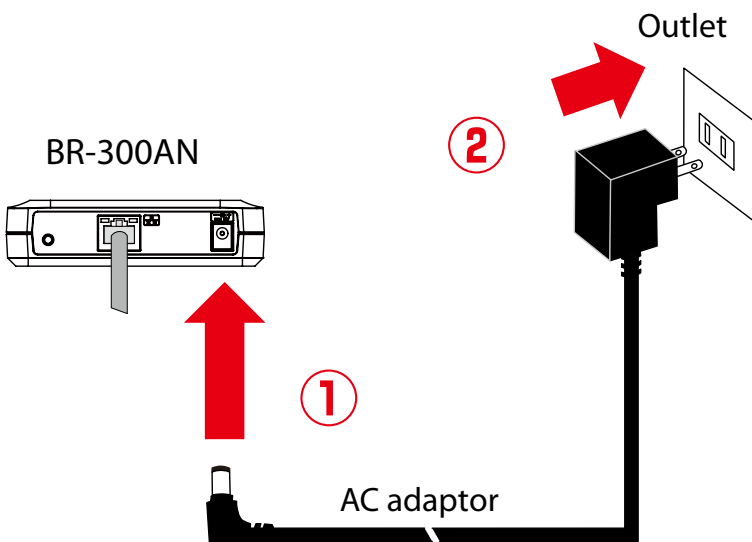

3. When the POWER LED on top of BR-300AN turns Red, press and hold the push switch on the front. Release the push switch when the WLAN LED and STATUS LED start blinking Green together (it may take 20sec until blinking). BR-300AN will start operating in the Configuration Mode and you will be ready to configure BR-300AN from the PC.

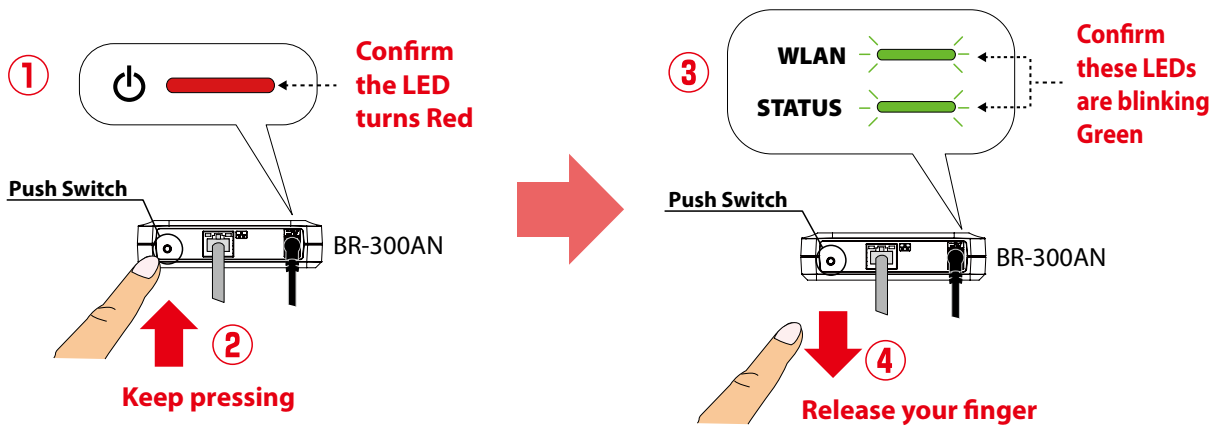

4. Start a Web browser (Internet Explorer, Safari, etc) on the PC you are using for the setup. The Web page of BR-300AN is displayed.

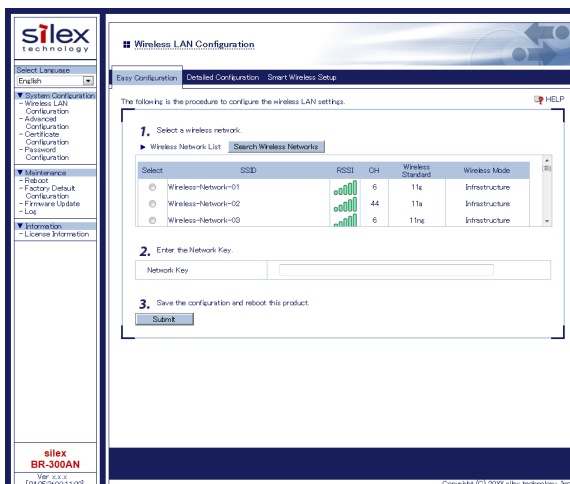

**Note**

- If the Web page is not displayed, enter "**http://silex**" in the address bar of the Web browser and press the Enter key.

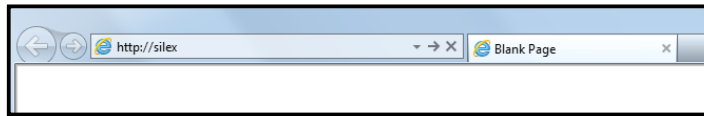

- If a password is set to BR-300AN, a password entry screen is displayed. Enter the password and click **Login**.
- The password entry screen is not displayed at the initial setup. Go on to **5** then.

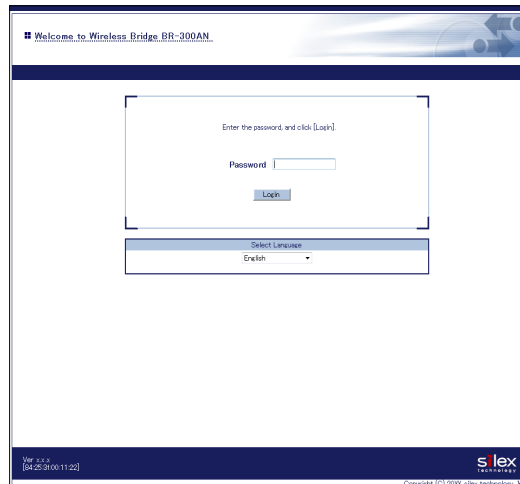
**TIP**

- To start the configuration, the PC and BR-300AN need to communicate each other properly.
- Confirm that an IP Address is correctly configured to the PC.
- If a wireless LAN is enabled on your PC, please disable it.
- If a static IP address is set to the PC, the Web configuration interface cannot be displayed in the following cases:
 - An IP address of the different segment is entered to the address bar, when the default gateway address is not configured to the PC.
 - A URL ("www.silextechnology.com", etc.) is entered to the address bar when the name resolution is disabled (DNS server address is not registered or NetBIOS is disabled).

5. Select **Log** to show a list of the system logs and click **Remove** to delete them.

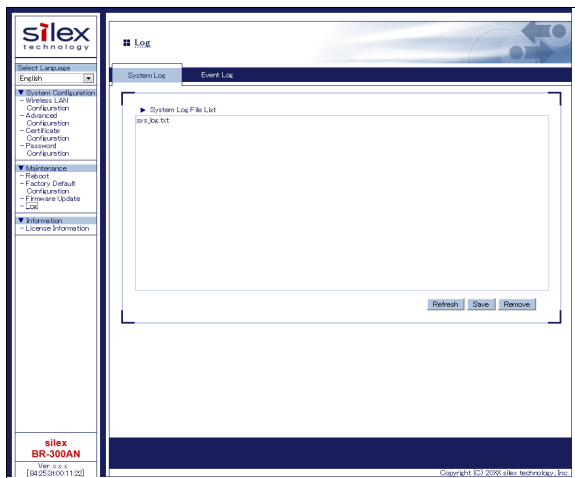

• The system log files cannot be deleted individually.

6. Click **OK** to a confirmation message.

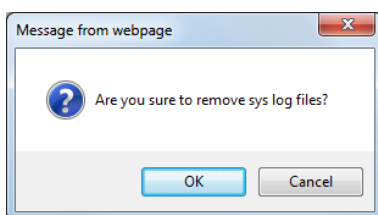

• If **Cancel** is clicked, the system log will not be deleted.

Note

The system log has been deleted.

Retrieving Event Log

How to retrieve the event log is explained.

The event log saved on BR-300AN can be accessed from the Web configuration interface.

1. Connect BR-300AN and the PC using a network cable.

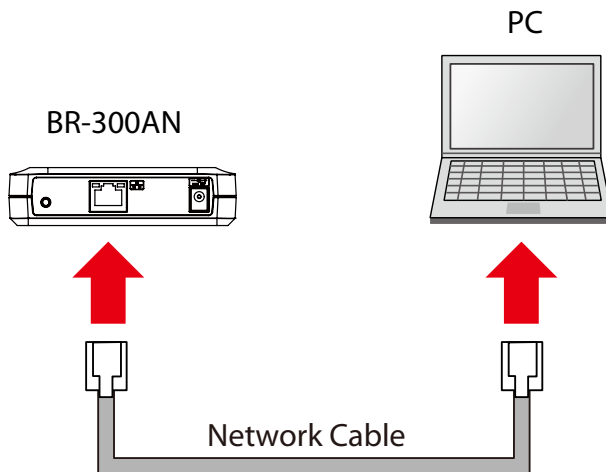

2. Connect the AC adaptor to BR-300AN, and the AC adaptor's plug to an electrical outlet.

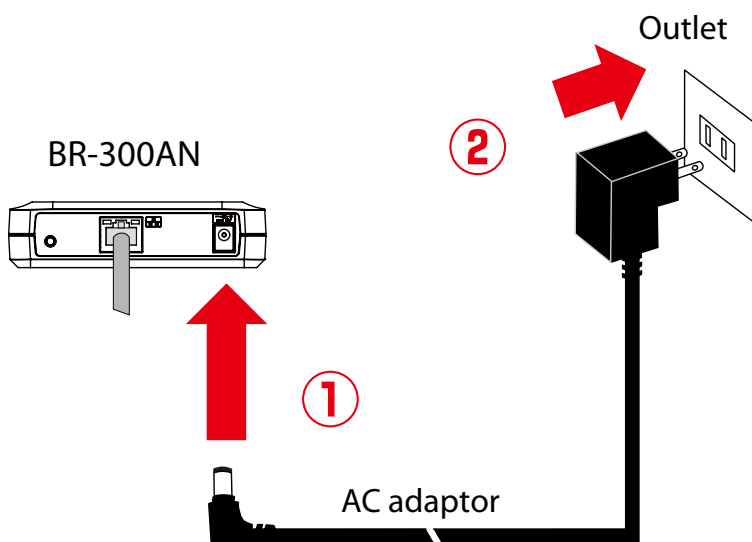

- When the POWER LED on top of BR-300AN turns Red, press and hold the push switch on the front. Release the push switch when the WLAN LED and STATUS LED start blinking Green together (it may take 20sec until blinking). BR-300AN will start operating in the Configuration Mode and you will be ready to configure BR-300AN from the PC.

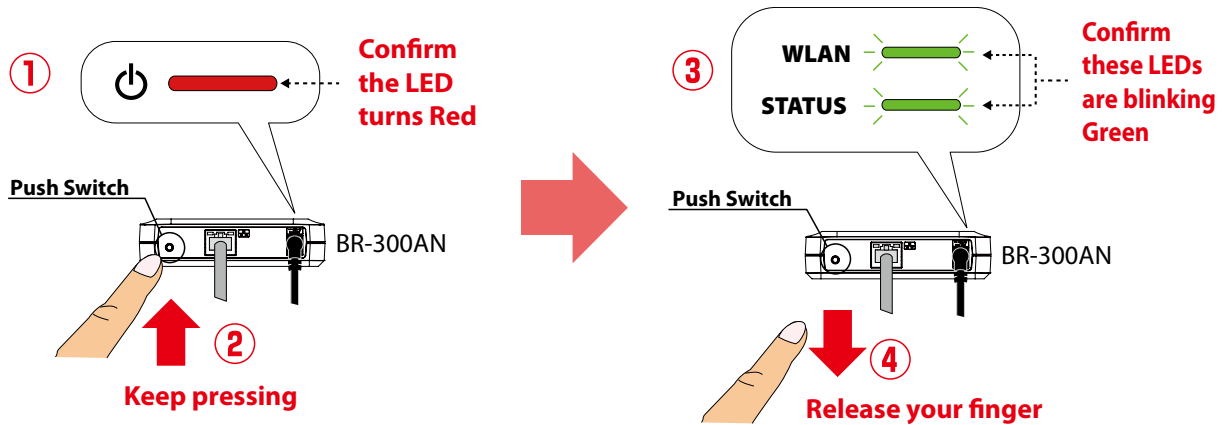

- Start a Web browser (Internet Explorer, Safari, etc) on the PC you are using for the setup. The Web page of BR-300AN is displayed.

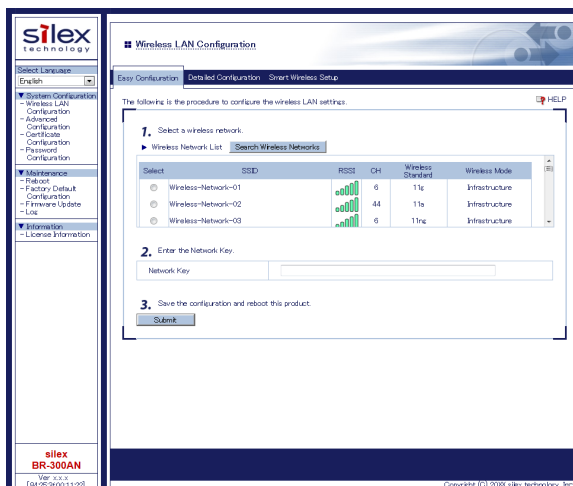

**Note**

- If the Web page is not displayed, enter "**http://silex**" in the address bar of the Web browser and press the Enter key.

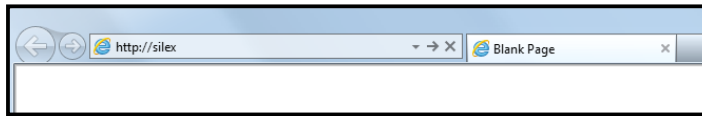

- If a password is set to BR-300AN, the password entry screen is displayed. Enter the password and click **Login**.
- By defaults, the password entry screen is not displayed. Go on to **5** then.

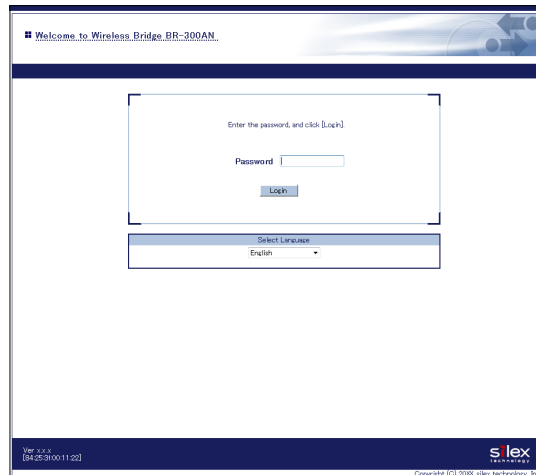
**TIP**

- To start the configuration, the PC and BR-300AN need to communicate each other properly.
- Confirm that an IP Address is correctly configured to the PC.
- If a wireless LAN is enabled on your PC, please disable it.
- If a static IP address is set to the PC, the Web configuration interface cannot be displayed in the following cases:
 - An IP address of the different segment is entered to the address bar, when the default gateway address is not configured to the PC.
 - A URL ("www.silextechnology.com", etc.) is entered to the address bar when the name resolution is disabled (DNS server address is not registered or NetBIOS is disabled).

5. Click **Log - Event Log** to display the event log.

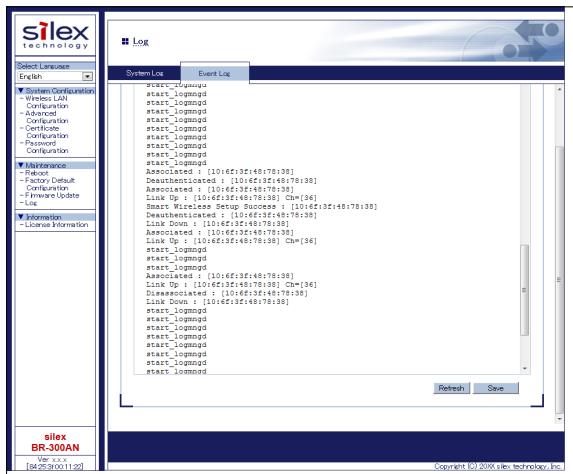

6. Click **Save** to save the event log.



TIP

- The event log can only be saved to one file.

7. When the message appears to confirm where to save the event log file, click **Save**.



- If ▼ is clicked, **Save as** option can be selected.

Note

The event log has been saved.

Time Synchronization of Log

BR-300AN has the NTP client function. The time of BR-300AN can be synchronized with the NTP server to describe it on the system log and event log.

To configure the NTP setting, open the Web page of BR-300AN and click **Advanced Configuration** from the menu. The setting can be configured at **NTP Configuration**.



Note

- For how to access the Web page of BR-300AN, refer to **5-1. How to Access Web Configuration Interface**.
- For details on the NTP setting, refer to **A-1. List of All Settings**.

5-4. Address Management Table

In **Multi-Client Mode**, up to 16 non-wireless devices can be shared over network by saving combination of MAC address and IP Address of such devices to BR-300AN.

The combination information is saved automatically when BR-300AN started communication with non-wireless devices, but if the address management table feature is used, it is possible to manually add or delete the combination information.

About Address Management Table Feature

How to register combination of MAC address and IP address will differ depending on whether the address management table feature is enabled or disabled (ON/OFF).

Following shows the detailed registration method for each case.

When Address Management Table Feature is OFF

When BR-300AN is turned on, combination of MAC address and IP address is not registered. Such information is automatically registered when BR-300AN started communication with the non-wireless device.

When the connected non-wireless device has been idle for a certain amount of time (5mins), combination information of such device is deleted. After it is deleted, bridge from wireless network will no longer continue for that device.

**Note**

- When the connected non-wireless device has a sleep mode and communication from that device is lost due to sleep mode for 5 mins, BR-300AN cuts communication from it. To avoid this problem, disable the sleep mode on the non-wireless device or enable the address management table feature on BR-300AN.

When Address Management Table Feature is ON

When BR-300AN is turned on, information of management tables (IPv4/IPv6) is used as combination of MAC address and IP address.

The combination information is automatically registered when BR-300AN started communication with the non-wireless device and it is also possible to manually add or delete the combination information. When the combination information is updated, it is registered to the management table. Once registered, the combination information will not be deleted automatically.



- Up to 16 sets of combination information can be registered to the management table. If 16 sets of information have already been registered, no more devices can be bridged using BR-300AN. Please be sure to delete unnecessary information.

Registering Address to Management Table

Following explains how to register combination of MAC address and IP address to management tables (IPv4/IPv6).

1. In the Web configuration interface of the BR-300AN, click **Advanced Configuration**.

Name	Value
LAN Interface	AUTO
Network Device Address	
Client Mode	Multi-Client Mode

Name	Value
DHCP	DISABLE
IP Address	0.0.0.0
Subnet Mask	0.0.0.0
Default Gateway	0.0.0.0

Name	Value
Time before turning into Configuration Mode (sec)	5
Time before starting Smart Wireless Setup (sec)	10

Name	Value

- At the address management table, enter the MAC address and IP address and click **Add**. Repeat the same process to register more sets of information.

The screenshot shows the 'Address Management Table Configuration' window. The 'Name' field is set to 'Address Management Table Function'. The 'Address Management Table Function' dropdown is set to 'ON'. There are two rows for configuration:

- Management Table (for IPv4):** The 'MAC Address' field contains '8423F001138' and the 'IP Address' field contains '192.168.20.134'. There are 'Add' and 'Remove' buttons next to this row.
- Management Table (for IPv6):** The 'MAC Address' and 'IP Address' fields are empty. There are 'Add' and 'Remove' buttons next to this row.

At the bottom of the window, there are 'Submit' and 'Reset' buttons.

- The added combination information is displayed in the list. Click **Submit**.

The screenshot shows the 'Address Management Table Configuration' window after several entries have been added. The 'Management Table (for IPv4)' section now contains a list of entries:

- MAC Address: 8423F001138, IP Address: 192.168.20.134
- MAC Address: 8423F001132, IP Address: 192.168.20.134
- MAC Address: 8423F001144, IP Address: 192.168.20.145
- MAC Address: 8423F001192, IP Address: 192.168.20.198
- MAC Address: 8423F001196, IP Address: 192.168.20.197

The first entry in the list is highlighted in blue. The 'Management Table (for IPv6)' section remains empty. The 'Submit' and 'Reset' buttons are still visible at the bottom.

Deleting Address from Management Table

Following explains how to delete combination of MAC address and IP address from management tables (IPv4/IPv6).

1. In the Web configuration interface of the BR-300AN, click **Advanced Configuration**.

2. At the address management table, select combination of MAC address and IP address from the list and click **Remove**. Repeat the same process to delete more sets of information.



- To select multiple items, hold down the Ctrl key to select them.

Note

3. Click **Submit**.

Name	Value
Address Management Table Function	OK <input type="button" value="v"/>
Management Table (for IPv4)	MAC Address: <input type="text"/> IP Address: <input type="text"/> <input type="button" value="Add"/> <input type="text"/> <input type="button" value="Remove"/>
Management Table (for IPv6)	MAC Address: <input type="text"/> IP Address: <input type="text"/> <input type="button" value="Add"/> <input type="text"/> <input type="button" value="Remove"/>

5-5. Maintenance

Restarting

How to restart BR-300AN by unplugging the AC adaptor:

1. Unplug the AC adaptor of BR-300AN from the outlet.

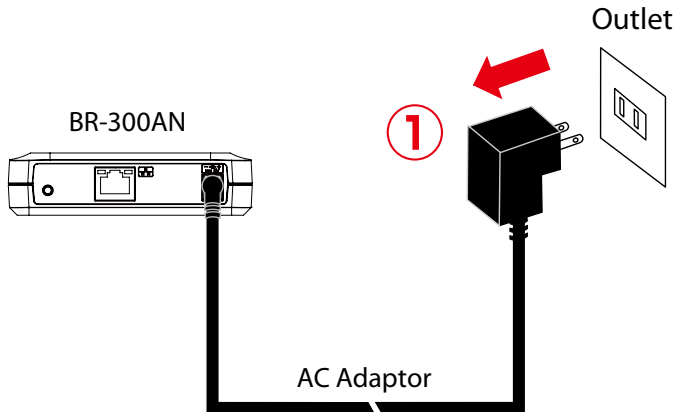

2. Plug the AC adaptor back into the outlet.

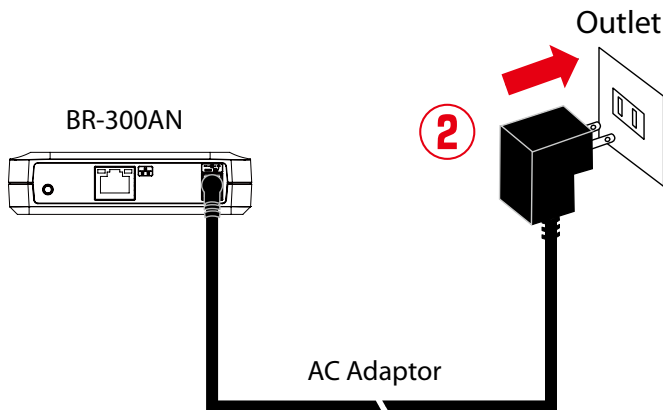

3. When the POWER LED turns Red, the restart is completed. After the restart, the BR-300AN will start in a normal mode.

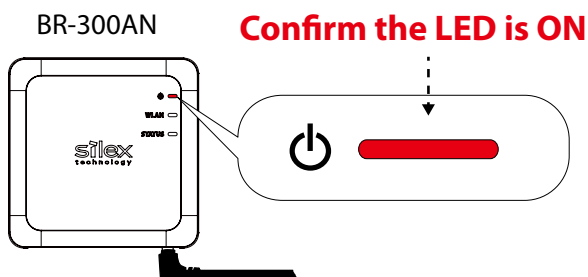

How to restart BR-300AN using the Web configuration interface:

1. Start the BR-300AN in **Configuration Mode** and login to the Web configuration interface using your Web browser.

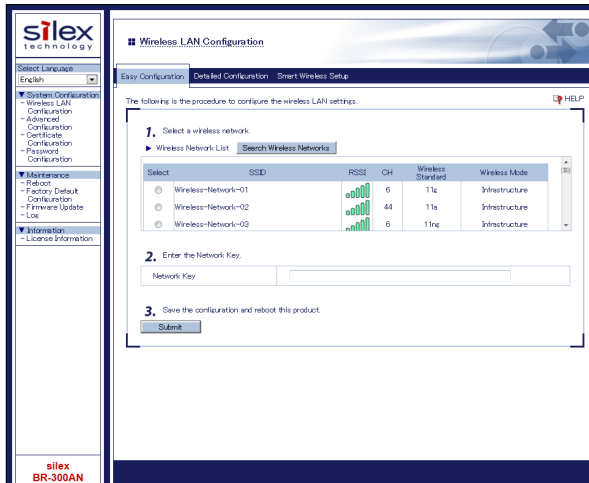

2. From the left menu on the Web configuration interface, click **Maintenance - Restart**. In the page displayed, click **Yes**.

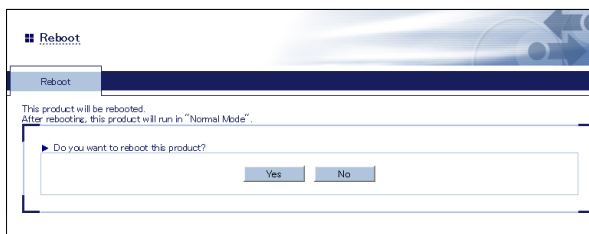

3. When the POWER LED turns Red after all LEDs turn off, the restart is completed. After the restart, the BR-300AN will start in a normal mode.

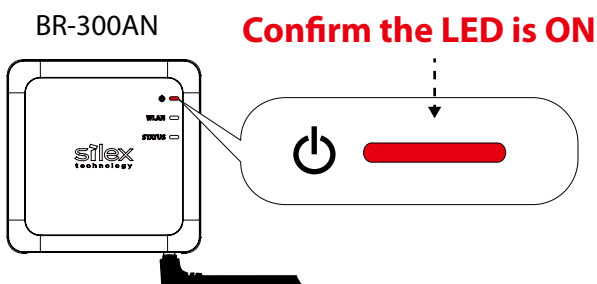

Factory Default Configuration

How to reset BR-300AN to factory defaults using the Push Switch:

1. Unplug the AC adaptor of BR-300AN from the outlet.

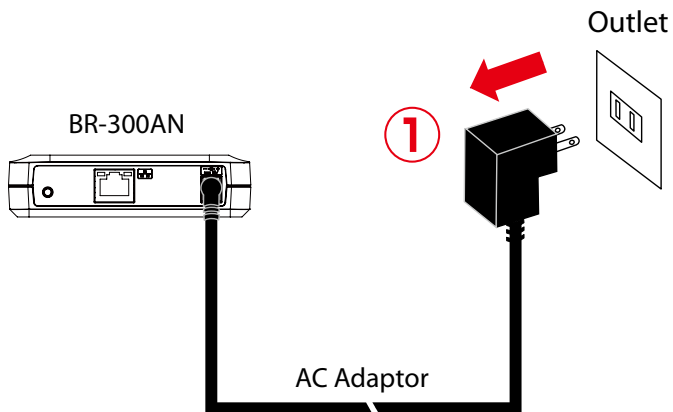

2. Press and hold the push switch on the front while inserting the AC adaptor back into the electrical outlet.

When the WLAN LED turns from Green to Red, the factory default configuration is completed. BR-300AN will run in a normal mode then.

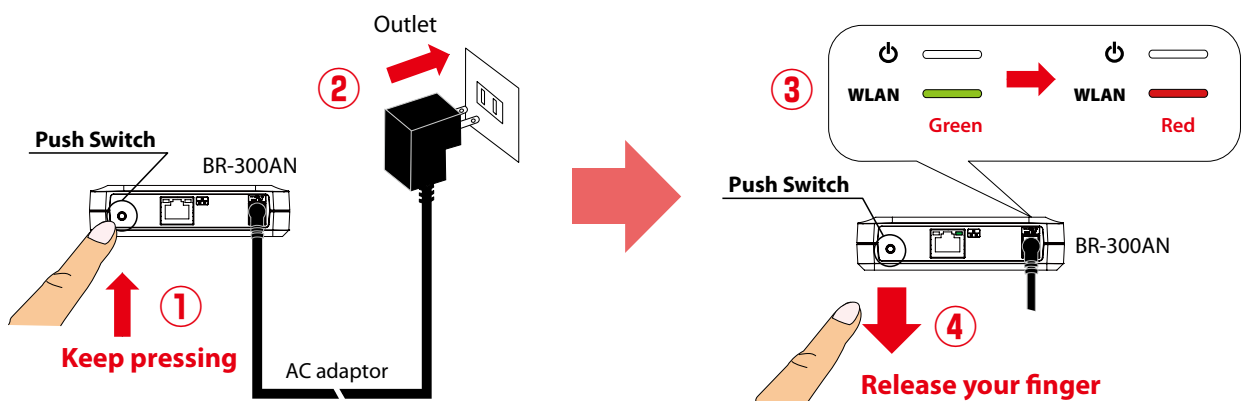

How to reset BR-300AN to factory defaults using the Web configuration interface:

1. Start the BR-300AN in **Configuration Mode** and login to the Web configuration interface using your Web browser.

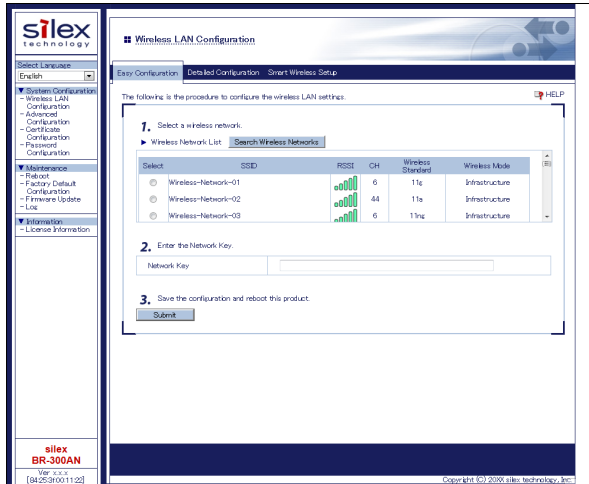

2. From the left menu on the Web page, click **Maintenance - Initialize System Configuration**. In the page displayed, click **Yes**.

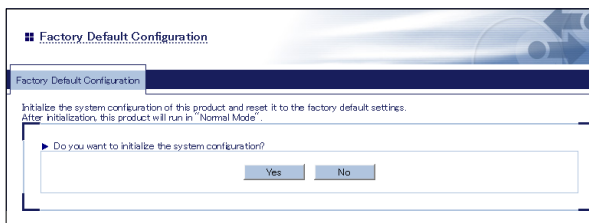

3. After the factory default configuration is completed, the BR-300AN will automatically restart. When the POWER LED turns Red after all LEDs turn off, the restart is completed. After the restart, the BR-300AN will start in a normal mode.

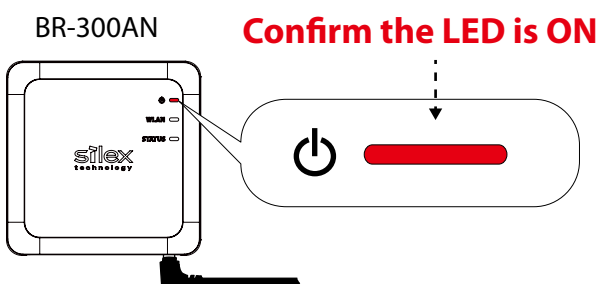

Firmware Update

The latest firmware file can be downloaded from our website.

See the instructions below to download the firmware file. For how to upload the firmware file to BR-300AN, refer to the firmware update procedure sheet file contained in the firmware file you download.



- The current firmware version can be identified at the bottom left of the Web configuration interface.

Note

How to download the firmware file:

1. Access our website below.

URL	
USA / Europe	https://www.silxtechnology.com/

2. Go to the support section and download the firmware file.

A. Appendix

A-1. List of All Settings

The BR-300AN has the following configuration items:

Wireless Configuration - Easy Configuration	
Select a wireless network.	
Details	Select the SSID of the Access Point (or other wireless devices) to connect from Wireless Network List .
Range	Access Point of the wireless network to connect
Default Value	(None)
Enter the Network Key.	
Details	Enter the WEP Key or Pre-Shared Key of the wireless network for Network Key .
Range	WEP Key or Pre-Shared key
Default Value	(None)
Note	For network key, usable characters will differ depending on the AP to connect. For details on WEP key, refer to WEP Key 1-4 at A-1. List of All Settings . For details on Pre-Shared key, refer to Pre-Shared Key at A-1. List of All Settings .

Wireless LAN Configuration - Wireless LAN Basic Configuration

Operating Mode

Details	This is a connection mode to connect to wireless LAN.
Range	Infra.
Default Value	Infra.
Note	Infra. (Infrastructure mode) only

Wireless Standard

Details	Select the wireless standard.
Range	AUTO / 2.4GHz / 5GHz
Default Value	AUTO
Note	Access Points of the selected wireless standard will be connected.

SSID

Details	Set the SSID to connect to the wireless network (up to 32 characters).
Range	Up to 32 characters
Default Value	SXxxxxxx (xxxxxx is the last 6 digits on MAC address of the BR-300AN.)
Note	The SSID is an ID that distinguishes a wireless LAN network from others. For wireless devices to communicate with each other on a wireless network, they must share the same SSID.

SSID Filter

Details	Enable/Disable the SSID filter.
Range	ON / OFF
Default Value	OFF
Note	If there are too many SSIDs on the wireless network and you fails to connect to the target Access Point, select ON . When ON is selected, only the registered SSIDs will be shown on Wireless Network List . The Smart Wireless Smart feature will become unavailable then.

Network Authentication

Details	Select the network authentication mode.
Range	Open / Shared / WPA2 / WPA/WPA2 Mixed Mode
Default Value	Open

IEEE802.1X Authentication

Details	Enable/Disable the IEEE802.1X authentication (ON/OFF).
Range	OFF / ON
Default Value	OFF
Note	This function can be used only when WPA2 or WPA/WPA2 Mixed Mode is selected as network authentication mode.

Wireless LAN Configuration - WEP Configuration	
WEP	
Details	Enable/Disable the WEP encryption. If WEP encryption is used, wireless communication will be encrypted using the settings for " WEP Key 1-4 " and " Key Index ".
Range	ON/OFF
Default Value	OFF
Note	If encryption is not enabled, data is not encrypted and is sent as is. To ensure higher security, enabling encryption is recommended.
Key Index	
Details	Select the number of the WEP key to use for encryption (1-4). This setting must be the same as that of your wireless device.
Range	1 - 4
Default Value	1
WEP Key1-4	
Details	Set the WEP key for WEP encryption. Up to 4 WEP keys can be set. This setting must be the same as that of your wireless devices. A WEP key must be entered using hexadecimal or alphanumeric characters.
Range	5 or 13 characters 10 or 26 digit hexadecimal value
Default Value	(None)
Note	In most cases, alphanumeric characters are used. Enter 5 characters if the key size is 64bit or 13 characters if the key size is 128bit. For Hexadecimal, a value consists of numbers (0-9) and English letters (A-F). Enter a 10-digit value if the key size is 64bit or a 26-digit value if the key size is 128bit. Usable characters will differ depending on the AP to connect.

Wireless LAN Configuration - WPA/WPA2 Configuration	
Encryption Mode	
Details	Select the encryption mode to use for WPA2 or WPA/WPA2 Mixed Mode authentication.
Range	AES/AUTO
Default Value	AES
Note	When the network authentication mode is WPA2 , AUTO cannot be used.
Pre-Shared Key	
Details	Set the Pre-Shared Key to use for encryption. The Pre-Shared Key is a keyword used to create the encryption key. It is also referred to as 'network key' or 'password'.
Range	8-63 alphanumeric characters 64 hexadecimal value
Default Value	silex technology, Inc.
Note	In most case, alphanumeric characters are used (8-63 characters). For Hexadecimal, a value consists of numbers (0-9) and English letters (A-F). * This setting must be the same as that of your wireless devices. Usable characters will differ depending on the AP to connect.

Wireless LAN Configuration - IEEE802.1X Authentication Configuration	
IEEE802.1X Authentication Type	
Details	Select the EAP authentication mode (Extensible Authentication Protocol) for IEEE802.1X authentication.
Range	EAP-TLS / EAP-TTLS / PEAP / EAP-FAST / LEAP
Default Value	EAP-TLS
Note	EAP-TLS Provides two-way authentication between the client and RADIUS server using a certificate. EAP-TTLS, PEAP This is the authentication method using EAP-TLS, providing the client authentication using a user name / password. EAP-FAST In this authentication, the authentication process is tunneled by the PAC (Protected Access Credential) which is issued from the RADIUS server. LEAP One kind of EAP protocols used for PPP authentication. The authentication performs using a user name / password between the RADIUS server and client.

Wireless LAN Configuration - Inner Authentication Method Configuration

Inner Authentication

Details	Select the authentication protocol to use for EAP-TTLS. In case of PEAP, only MSCHAPv2 can be used.
Range	PAP / CHAP / MSCHAP / MSCHAPv2
Default Value	PAP

Wireless LAN Configuration - Server Certificate Verification Configuration

Server Certificate Verification

Details	Set whether to verify that the server certificate is issued from a trusted root certification authority when EAP-TTLS or PEAP authentication mode is used (ON/OFF).
Range	OFF / ON
Default Value	OFF
Note	When ON is selected, the CA certificate needs to be registered.

Wireless LAN Configuration - IEEE802.1X User Configuration

User Name in IEEE802.1X

Details	Set the user name for IEEE802.1X authentication. The user name is used by the RADIUS server to identify a client.
Range	Up to 64 characters
Default Value	(None)

Password

Details	Set the password for IEEE802.1X authentication. The password is used by the RADIUS server to identify a client.
Range	Up to 32 characters
Default Value	(None)

Wireless LAN Configuration - EAP-FAST Configuration

PAC Auto-distribution

Details	Enable/Disable the automatic distribution of the PAC (Protected Access Credential) in EAP-FAST authentication.
Range	OFF / ON
Default Value	OFF
Note	When OFF is selected, the PAC file generated by the server will need to be registered.

Wireless LAN Configuration - IEEE802.1X Network Device Configuration

Device Filter

Details	Enable/Disable filtering for the devices registered to the network device address.
Range	OFF / ON
Default Value	ON
Note	If the device filter is disabled, communication will be bridged even for devices not registered to the network device address. The device authentication (one security feature of IEEE802.1X authentication) will not be assured then.

Network Device Address

Details	Register the MAC address of devices to be connected to LAN port of the BR-300AN when the IEEE802.1X authentication is used.
Range	MAC address (in Multi-Client Mode , up to 16 addresses can be registered)
Default Value	(None)
Note	One MAC Address can be registered for Single Client Mode while 16 MAC Addresses can be registered for Multi-Client Mode .

Wireless LAN Configuration - Smart Wireless Setup

PIN Code

Details	The PIN code of BR-300AN is displayed.
Range	The value is automatically generated by clicking the button.
Default Value	Automatically generated

Smart Wireless Setup Execution

Details	Execute the wireless configuration by Smart Wireless Setup.
Range	(Smart Wireless Setup Execution button)
Default Value	-

Advanced Configuration - Advanced Configuration

LAN Interface

Details	Configure the physical network type. Usually, " AUTO " is used.
Range	AUTO / 10BASE-T-Half / 10BASE-T-Full / 100BASE-TX-Half / 100BASE-TX-Full / 1000BASE-T-Full
Default Value	AUTO
Note	If a LINK LED on the connected device does not light on when BR-300AN is powered on, change the network type to that of the connected device.

Network Device Address

Details	Set the MAC Address of the network device to be connected to a LAN port of the BR-300AN.
Range	MAC Address
Default Value	(None)
Note	In most cases, it is recommended to leave this field blank, as the BR-300AN automatically detects the MAC Address from the network packets sent from the connected device.

Client Mode

Details	Set the operating mode.
Range	Single Client Mode / Multi-Client Mode
Default Value	Single Client Mode
Note	Select Single Client Mode to bridge only one device connected to a LAN port of the BR-300AN. In Single Client Mode , not only TCP/IP but various communication protocols can be used. Select Multi-Client Mode to bridge several devices using a HUB on the LAN port of BR-300AN. In Multi-Client Mode , only TCP/IP (IPv4, IPv6) protocol can be used.

Advanced Configuration - TCP/IP Configuration

DHCP

Details	Enable/Disable the DHCP protocol. To assign an IP address using DHCP, the DHCP server must be running in your subnetwork.
Range	ENABLE/DISABLE
Default Value	DISABLE

IP Address

Details	Set the IP address. If the DHCP is enabled on your network, the IP Address obtained from it will be applied.
Range	0.0.0.0 - 255.255.255.255
Default Value	0.0.0.0

Subnet Mask

Details	Set the subnet mask. If the DHCP is enabled on your network, the Subnet Mask obtained from it will be applied.
Range	0.0.0.0 - 255.255.255.255
Default Value	0.0.0.0
Note	When set to "0.0.0.0", a subnet mask appropriate for the IP address is automatically assigned.

Default Gateway

Details	Set the gateway address. If "0.0.0.0" is set, this setting is disabled. When the DHCP is enabled on your network, the Default Gateway obtained from it will be applied.
Range	0.0.0.0 - 255.255.255.255
Default Value	0.0.0.0

Advanced Configuration - Push Switch Configuration	
Time before turning into Configuration Mode	
Details	Specify the period of time until the BR-300AN turns into the Configuration Mode. If the Push Switch is pressed for the period of time specified here, the BR-300AN will turn into the Configuration Mode.
Range	5-60 (sec)
Default Value	5
Note	* Please keep 5 sec or more interval than the value you specify at Time before starting Smart Wireless Setup .
Time before starting Smart Wireless Setup	
Details	Specify the period of time until Smart Wireless Setup is started. If the Push Switch is pressed for the period of time specified here, Smart Wireless Setup will start.
Range	5-60 (sec)
Default Value	10
Note	* Please keep 5 sec or more interval than the value you specify at Time before turning into Configuration Mode .

Advanced Configuration - Roaming Configuration	
Roaming Threshold	
Details	Set the roaming threshold value (1-60). If a greater value is set, frequency of roaming is increased, however, communication may become unstable.
Range	1-60
Default Value	15

Advanced Configuration - NTP Configuration

NTP

Details	Enable/Disable the NTP protocol.
Range	ENABLE/DISABLE
Default Value	DISABLE

NTP Server

Details	Set the domain name or IP Address for NTP server.
Range	In case of the domain name; Alphanumeric character string (0-128 characters) In case of the IP Address; 0.0.0.0 - 255.255.255.255
Default Value	(None)
Note	To synchronize time with the NTP server using the domain name, the following conditions must be met: - DHCP is enabled on the TCP/IP setting of BR-300AN. - DHCP server is distributing the IP address of DNS server.

Local Time Zone

Details	Set the local time zone.
Range	-12:00 - +12:00
Default Value	+9:00

Advanced Configuration - Address Management Table Configuration

Address Management Table Configuration

Details	Enable/Disable the address management table feature to use in Multi-Client Mode (ON/OFF) . When ON is set, combination information of MAC address and IP address will be used from management tables (IPv4/IPv6) for connected non-wireless devices.
Range	OFF / ON
Default Value	OFF
Note	This function can be used when Multi-Client Mode is set for Client Mode. When the address management table feature is ON , combination information of MAC address and IP address will be used from management tables for connected non-wireless devices. When a new address is found by BR-300AN, it will automatically be registered to the management table. When the address management table feature is OFF , the management table setting is not used. Combination information of MAC address and IP address is created dynamically and such information will automatically be deleted when it is not accessed for 5 mins.

Management Table (IPv4)

Details	Register combination of MAC address and IP address (IPv4).
Range	Up to 16 sets of MAC address and IP address (IPv4)
Default Value	(None)

Management Table (IPv6)

Details	Register combination of MAC address and IP address (IPv6).
Range	Up to 16 sets of MAC address and IP address (IPv6)
Default Value	(None)

Certificate Configuration - Client Certificate

Certificate File

Details	Register the certificate used to authenticate the BR-300AN by IEEE802.1X authentication.
Range	A certificate file to authenticate the BR-300AN by IEEE802.1X authentication.
Default Value	The certificate file must support the followings: - File format PKCS#12 format (*.p12, *.pfx) - Certificate version V3 - Public key algorithm RSA - Public key size 512bit, 1024bit, 2048bit - Signature algorithm SHA1/SHA2(SHA-224,SHA-256,SHA-384,SHA-512)withRSA, MD5withRSA - Extended key usage "Client authentication(1.3.6.1.5.5.7.3.2)" is included.

Password

Details	This is the password to read a secret key from the client certificate.
Range	1 - 32 characters
Default Value	(None)

Certificate Configuration - CA Certificate

Certificate File

Details	This is the CA certificate file to authenticate the certificate sent from the RADIUS server when the IEEE802.1X authentication is used.
Range	CA certificate file to authenticate the certificate sent from the RADIUS server when the IEEE802.1X authentication is used.
Default Value	The certificate file must support the followings: <ul style="list-style-type: none"> - File format DER format(*.der), PEM format(*.pem) - Public key algorithm RSA - Public key size 512bit, 1024bit, 2048bit - Signature algorithm SHA1/SHA2(SHA-224,SHA-256,SHA-384,SHA-512)withRSA, MD5withRSA

Certificate Configuration - PAC File

PAC File

Details	When the PAC (Protected Access Credential) is manually distributed in EAP-FAST authentication method, register the PAC file generated from the server.
Range	A PAC file generated from the server

Password

Details	This password is used to analyze the PAC file generated by server.
Range	1 - 63 characters
Default Value	(None)

Password Configuration

Password

Details	Configure the password to manage the BR-300AN. This password is used for authentication to login to the Web configuration interface of BR-300AN.
Range	Up to 15 characters
Default Value	(None)

A-2. Troubleshooting

This section provides the solutions for possible troubles you may experience when you are configuring or using the BR-300AN.

My Access Point is not displayed in the Wireless Network List of the Web configuration interface.

The Access Point may not be active.

Solution	Please check that the Access Point is operating correctly.
----------	--

The Access Point may be operating in a stealth mode.

Solution	Configure the detailed settings of the wireless network at Detailed Configuration of the Web configuration interface to connect to the Access Point. Remember that Access Points operating in a stealth mode will not be displayed in the list.
----------	--

Too many wireless devices may be operating, exceeding the maximum number of devices the BR-300AN can show on (up to 32 devices).

Solution	Up to 32 wireless devices can be displayed at Wireless Network List . To show your Access Point in the list, use SSID Filter so that only the specified networks are displayed there. Even when the Access Point is not displayed in the list, it can be connected by configuring the wireless settings at Detailed Configuration of the Web configuration interface.
----------	--

I failed to connect to a wireless network using Smart Wireless Setup.

The WPS feature may be disabled on the Access Point.

Solution	Check that the Access Point supports the WPS feature. Depending on the Access Point, you may need to manually enable the WPS feature. For details, see the operating manual that came with your Access Point.
----------	---

The SSID Filter may be enabled on the BR-300AN.

Solution	Disable the SSID Filter at Detailed Configuration of the Web configuration interface. If the SSID Filter is enabled, configuration using Smart Wireless Setup does not work.
----------	---

A LAN port error has occurred (POWER LED: Blinks rapidly, WLAN LED: OFF, STATUS LED: ON).

The bridge feature may be aborted as the non-wireless device is unplugged and changed to the other device on the LAN port.

Solution	Restart the BR-300AN. In Single Client Mode , if the non-wireless device is unplugged and changed to the other device, BR-300AN will abort bridging of that device, taking such occurrence as an error. Also, when the MAC address filtering is used to restrict the devices to bridge, you will need to change the setting registered to Network Device Address . This error does not occur in Multi-Client Mode . The restart is not required then.
----------	---

Several devices may have been connected to the BR-300AN using a HUB, though it is operating in **Single Client Mode**.

Solution	In Single Client Mode , connect only one device to the LAN port of BR-300AN. To use several devices, use Multi-Client Mode .
----------	--

I cannot access the non-wireless device connected to a LAN port of the BR-300AN.

The BR-300AN or non-wireless device may not be operating correctly.

Solution	Please check the LED status on BR-300AN. Please also check that the non-wireless device is properly powered on.
----------	---

The connection may be restricted by the MAC address filtering on BR-300AN.

Solution	See the setting at Network Device Address to check that access of the connected device is not restricted by the MAC address filtering.
----------	---

16 or more non-wireless devices may be connected when BR-300AN is operating in **Multi-Client Mode**.

Solution	Check how many non-wireless devices are connected to BR-300AN. Up to 16 non-wireless devices can be connected when BR-300AN is operating in Multi-Client Mode .
----------	---

16 sets of combination information may be registered to the management table.

Solution	When BR-300AN is operating in Multi-Client Mode and the address management table feature is enabled, up to 16 sets of combination information are automatically registered to the management table. As they are not deleted automatically after registered, please manually delete unnecessary ones.
----------	---

The connection to the non-wireless device is lost.

The connection may be timed out.	
Solution	<p>If the connected non-wireless device is idle and no communication occurs from it for 5 mins, BR-300AN automatically cuts a link with it. To recover the communication, try to do anything that can cause communication packets on the non-wireless device. For the connection not to be timed out again, it is recommended to enable the address management table feature on BR-300AN or to disable the sleep mode on the non-wireless device.</p> <p>(Example) If the connected non-wireless device is a printer and the printer has turned into a sleep mode, printing will become unavailable as BR-300AN will disconnect a link with the printer.</p> <p>To get printing ready again, wake up the printer from a sleep mode using the control panel on it to make a communication from the printer to BR-300AN.</p>

The imported IEEE802.1X certificate cannot be deleted.

It is impossible to delete the imported certificate only.	
Solution	<p>To delete the imported certificate, initialize the BR-300AN.</p> <p>NOTE: The imported certificate is validated only when it is used. Even if you keep the certificate, it has no impact on the authentication process since the imported certificate is used only with the compatible authentication method.</p>

I cannot connect to BR-300AN in Ad hoc mode.

BR-300AN does not support Ad hoc mode.	
Solution	Only Infrastructure mode can be used.