

Mesh Network System

BR-400AN

User's Manual



Copyright© 2017 silex technology, Inc. All rights reserved.

WA104900XE

Index

1. Introduction	1
1-1. Introduction	1
Disclaimers.....	1
Trademarks	1
1-2. Safety Instructions	2
1-3. Product Information and Customer Services	5
Product Information	5
Customer Support Center	5
2. Specifications.....	7
2-1. What is Mesh Network?.....	7
2-2. Features.....	8
2-3. Parts and Functions	10
2-4. Hardware Specification	12
2-5. Software Specification.....	14
2-6. Optional Utilities.....	15
What is AMC Manager®?	15
What is Mesh Monitor?	17
2-7. Wireless Interference Information.....	18
Notes of Use.....	18
DFS.....	20
2-8. Notes on Security	21
2-9. Restrictions	22
Restrictions on DFS Channels	22
3. How to Install BR-400AN	23
3-1. How to Install BR-400AN.....	23
Product Installation and Radio Distance.....	24
How to Turn on BR-400AN.....	25
3-2. Example of Installation.....	26

Configuring Mesh network using BR-400AN only	27
Connecting BR-400AN to your existing network.....	28
Dividing the Mesh network for each area	29
Connecting tablet devices or PCs wirelessly	30
4. How to Configure BR-400AN.....	31
4-1. Configuration via BR-400AN's Web Page	31
Accessing the BR-400AN's Web Page Using Configuration Mode	31
Accessing BR-400AN's Web Page over Network.....	34
Configuration via BR-400AN's Web Page	36
4-2. Bulk Configuration Using AMC Manager®	40
Preparation for Bulk Configuration	40
Starting Bulk Configuration	44
Product Installation.....	52
4-3. Configuration Change Using Mesh Monitor	54
5. List of Configuration Items	57
5-1. Configuration Items on BR-400AN's Web Page	57
Basic Configuration.....	58
Access Point Function Configuration Page	66
Access Point Function Extended Configuration Page.....	72
Option Configuration Page.....	74
Login Password Configuration Page.....	76
6. How to Connect Wireless Client Devices	77
6-1. How to Enable Access Point Feature on BR-400AN.....	77
How to enable the Access Point feature using the Web configuration interface.....	78
How to enable the Access Point feature using AMC Manager®	81
How to enable the Access Point feature using Mesh Monitor	89
6-2. How to Connect PCs or Tablets to BR-400AN	91
7. Maintenance Feature	93

7-1. Restart	93
How to restart BR-400AN by unplugging the AC adaptor.....	94
How to restart BR-400AN using the Web configuration interface.....	95
7-2. Factory Default Configuration.....	97
How to reset BR-400AN to factory defaults using the Push Switch	97
How to reset BR-400AN to factory defaults using the Web configuration interface	99
7-3. Firmware Update.....	101

8. Other Features 107

8-1. Mac Address Filter	107
Filter Type	107
MAC Address List	108
MAC Address Filter Setting	109
8-2. Saving Log.....	112
BR-400AN's System Log.....	112
Retrieving System Log	113
Deleting System Log	115

A. Appendix 117

A-1. Troubleshooting	117
----------------------------	-----



1. Introduction

Thank you for purchasing the Mesh Network System BR-400AN (hereinafter the "BR-400AN").

1-1. Introduction

This manual provides information on how to configure and use the BR-400AN. Please read the Safety Instructions carefully before you begin.

Disclaimers

- The unauthorized transfer or copying of the content of this manual, in whole or in part, without prior written consent is expressly prohibited by law.
- The content of this manual is subject to change without notice.
- This manual was prepared to accurately match the content of each OS, but the actual information shown on the computer monitor may differ from the content of this manual due to future OS version upgrades, modifications, and other changes.
- Although every effort was made to prepare this manual with the utmost accuracy, Silex Technology will not be held liable for any damages as a result of errors, setting examples, or other content.

Trademarks



- AMC Manager® is a registered trademark of silex technology.
- Microsoft and Windows are registered trademarks of Microsoft Corporation in the United States and/or other countries.
- Wi-Fi, Wi-Fi Protected Setup (WPS), Wi-Fi Protected Access (WPA), WPA2 are trademarks or registered trademarks of Wi-Fi Alliance.
- Other company names and product names contained in this manual are trademarks or registered trademarks of their respective companies.

1-2. Safety Instructions







This page provides the safety instructions for safe use of BR-400AN.

To ensure safe and proper use, please read the following information carefully before using BR-400AN.

< Meaning of the warnings >

	Warning	"Warning" indicates the existence of a hazard that could result in death or serious injury if the safety instruction is not observed.
	Caution	"Caution" indicates the existence of a hazard that could result in serious injury or material damage if the safety instruction is not observed.

< Meaning of the symbols >

	This symbol indicates the warning and caution. (Example:  "Danger of the electric shock")
	This symbol indicates the prohibited actions. (Example:  "Disassembly is prohibited")
	This symbol indicates the actions users are required to observe. (Example:  "Remove the AC plug from an outlet")



Warning

	<ul style="list-style-type: none"> - In the following cases, turn off the connected devices and unplug the AC plug of this product from a power outlet. Failure to follow these instructions may cause fire or an electrical shock. - When this product emits a strange smell, smoke or sound or becomes too hot to touch. - When foreign objects (metal, liquid, etc.) gets into this product. - When this product is dropped or the case is broken or cracked.
	<ul style="list-style-type: none"> - Do not disassemble or modify this product. It may cause fire, electrical shock or malfunction. - Do not disassemble or modify the AC adaptor that came with this product. It may cause fire, electrical shock or malfunction.
	<ul style="list-style-type: none"> - Do not cover up the vents on this product. The temperature inside may rise and cause fire or malfunction. - Do not place anything on top of this product. Also, do not place this product on top of the other product. Failure to do so may cause fire, electrical shock, malfunction or performance degradation. - Do not cover up this product with a cloth such as blanket or table cloth. The heat remains inside and it may cause fire or malfunction. - Do not place any objects on top of AC adapter, or do not cover it up with anything. Also, do not use the AC adapter on top of the heat/moisture retaining materials (carpet, sponge, cardboard, styrofoam, etc.). The accumulated heat may result in fire or malfunction. - Do not roll up or wrap the AC cord. It may cause fire or an electrical shock. - Do not plug or unplug the AC adaptor or any other cables with wet hands. It may cause an electrical shock or malfunction. - Do not move this product when the AC adapter is connected to it. The cable of AC adapter may be damaged, and which may result in fire or electric shock. - Keep the small parts out of reach of young children. If these are swallowed, consult a doctor immediately.
	<ul style="list-style-type: none"> - For use of the devices connected to this product, please follow all warnings, cautions and notices given by that manufacturer and carefully use them in a proper manner. Failure to follow these instructions may cause fire, electrical shock or malfunction. - Use the correct power voltage. Improper voltage may cause fire or an electrical shock. - If a ground wire is supplied with your device to use with, connect it to the ground terminal in order to prevent an electrical shock. Do not connect the ground wire to gas pipe, water pipe, lighting rod or telephone ground wire. It may cause malfunction. - Keep the cords and cables away from children. It may cause an electrical shock or serious injury. - Make sure that you have a secure scaffold when this product is installed or removed to/from a high place. There is a danger of falling.



Caution



- Use the AC adaptor supplied with this product. Other AC adaptors may cause malfunction.
- Do not place any objects on the cable or bend, twist, or pull it excessively.
- Do not use or store this product under the following conditions. It may cause malfunction.
 - Locations subject to vibration or shock
 - Shaky, uneven or tilted surfaces
 - Locations exposed to direct sunlight
 - Humid or dusty places
 - Wet places (kitchen, bathroom, etc.)
 - Near a heater or stove
 - Locations subject to extreme changes in temperature
 - Near strong electromagnetic sources (magnet, radio, wireless device, etc.)
 - Poorly ventilated locations (on bookshelf, rack, etc.)
- Do not step on this product. It may cause injury if the product is broken.
- Do not wire in a place where many people are walking by. They may trip over the cables and get injured.
- When installing this product to a high position, make sure that this product is firmly fixed so it does not drop for weight of the cables.



- This product may become hot when it is in use. Be careful of the heat when moving or removing this product.
- Do not pull on the cord to disconnect the plug from the power supply. The cord may be broken, which could result in fire or an electrical shock.
- Follow the law of each country when you discard this product.
- Verify all codes or cables are plugged correctly before using this product.



- When removing this product, disconnect the AC plugs of both this product and the other devices you are using with it.
- When this product will not be used for a long time, unplug the power cables of this product and the other devices you are using with it.

1-3. Product Information and Customer Services

Product Information

The services below are available from the Silex Technology website. For details, please visit the Silex Technology website.

URL	
USA / Europe	https://www.silextechnology.com/

- Latest firmware download
- Latest software download
- Latest manual download
- Support information (FAQ)

Customer Support Center

Customer Support is available by e-mail or telephone for any problems that you may encounter. If you cannot find the relevant problem in this manual or on our website, or if the corrective procedure does not resolve the problem, please contact Silex Technology Customer Support.

Contact Information		
USA	+1-657-218-5199	support@silexamerica.com
Europe	+49-2154-88967-0	support@silexeurope.com



Note

- Visit the Silex Technology website (<https://www.silextechnology.com/>) for the latest FAQ and product information.

2. Specifications

The Mesh network can easily be established using BR-400AN.

As 2.4GHz/5GHz wireless communication bands are supported, the wireless devices can easily be joined to the Mesh network after they are connected to BR-400AN via a wired LAN.

2-1. What is Mesh Network?

In the Mesh network, several Mesh-network compatible devices (hereinafter, "Mesh devices") are connected each other to configure a network without using Access Point. It allows communication in a wider area as the range of radio wave can be expanded by relay.

Also, Mesh devices communicate each other regularly to select a best route for relay. For example, if a device (BR-400AN(3)) has malfunctioned when the route (1) is used, the rest of devices will continue communication by rebuilding the route (2).

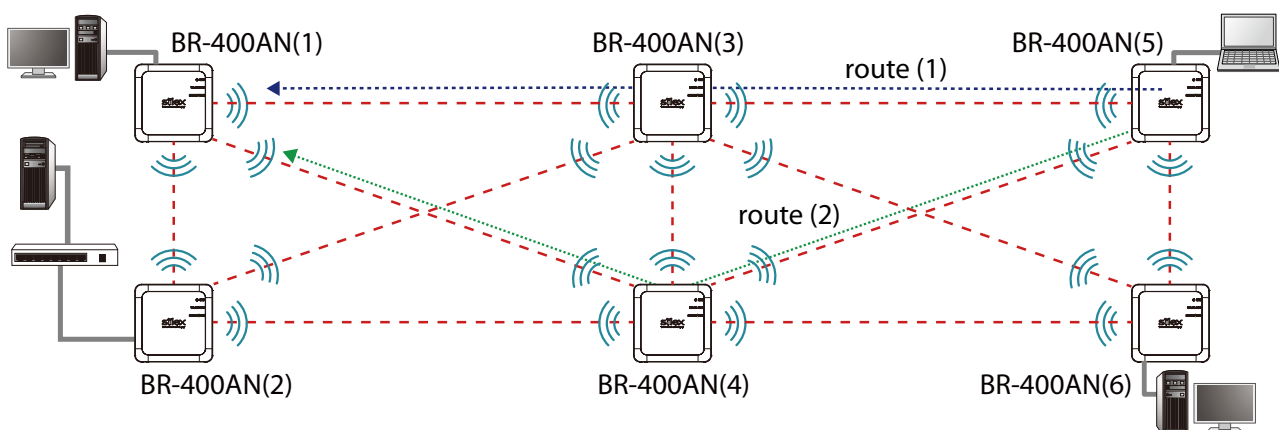

2-2. Features

BR-400AN has the following features:

Giving unlimited locations for your non-wireless devices

As you do not have to care wiring conditions in order to establish your environment, choices of location greatly expand in any kinds of scenes such as office, factory, school, commercial facility, etc. where the layout change is frequently required or effective layout of equipment needs to be carefully considered for a work line. Also, since the Mesh network can be created using two or more BR-400AN units, cost reductions could be expected as you will not have to prepare Access Point for each channel.

IEEE 802.11a/b/g/n

BR-400AN supports communications at both 2.4GHz/5GHz bands. Using 5GHz band will help to avoid radio interference with 2.4GHz band which is most commonly used in the market.

Advanced security

The following security features are supported:

- WEP (64bit/128bit)
- WPA-PSK (AUTO/TKIP/AES), WPA2-PSK (AUTO/AES)
- IEEE 802.1X, WPA-Enterprise (AUTO/TKIP/AES), WPA2-Enterprise (AUTO/AES)

Two types of operating mode

< Mesh Point mode (hereinafter, "MP mode") >

- A radio wave is relayed from the other Mesh devices in the Mesh network. Also, the wired devices can be used over the Mesh network via BR-400AN.

< Mesh Access Point mode (hereinafter, "MAP mode") >

- In addition to the MP mode function, Access Point function will run. BR-400AN can be used as Access Point to connect wireless client devices.

On-board storage chip with 1GB memory

The operating log data can be stored in the on-board storage chip for a long period of time. This will help you to quickly resolve the troubles that may occur during the use of BR-400AN.

Easy access to the Web configuration interface

Without changing the setting of the PC you use for setup, the Web configuration interface of BR-400AN can easily be accessed.

AMC Manager® (non-free program) / AMC Manager® Free (free program)

BR-400AN supports the total management software, "AMC Manager®".

The AMC Manager® provides the useful features as follows:

- Remote device control and monitoring
- Bulk configuration - IP address configuration - Firmware updates
- Visualization of the Mesh network using Mesh Monitor (option utility)



- For details on the "AMC Manager®" and "Mesh Monitor", please visit our homepage.

Note

2-3. Parts and Functions

The parts name and functions are as follows:

(FRONT)

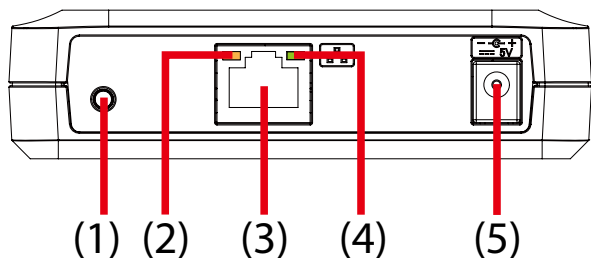

(1)	Push Switch	Start in Configuration Mode	Press and hold this switch for 5 sec while BR-400AN is active.
		Factory default configuration	Press and hold this switch while turning on BR-400AN and release it when the WLAN LED turns from Green to Red.
(2)	Status LED	Blink (Orange)	Waits for connection when the Link LED is turned off.
			Handles data communication when the Link LED is turned on.
(3)	LAN port	Connect a network cable.	
(4)	Link LED	ON	Has connected to a wired LAN.
(5)	AC connector	Connect an AC adaptor.	

(TOP)

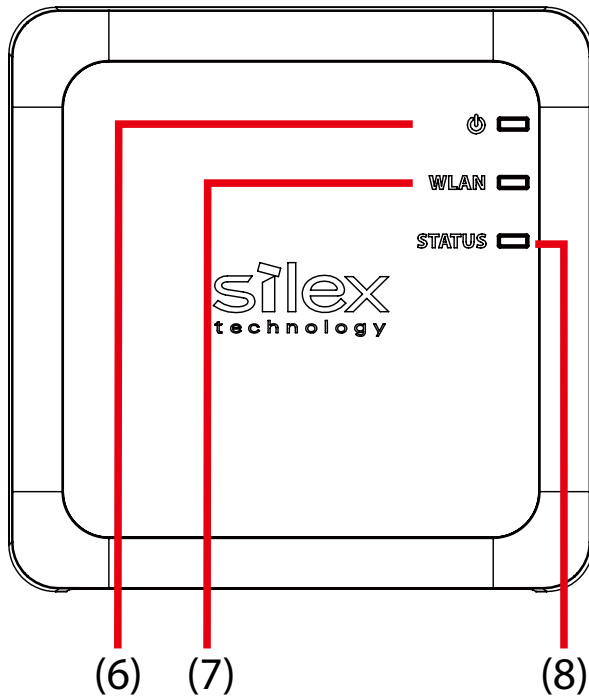

(BOTTOM)

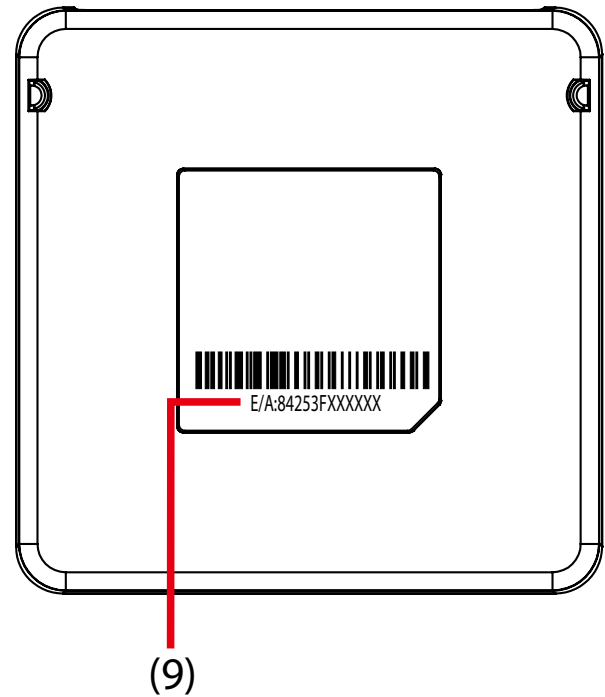

(6)	POWER LED	ON (Green)	Powered on.
		ON (Red)	Turns on when BR-400AN is started in Configuration Mode.
		* Turns green for 2 sec after BR-400AN is powered on and then turns off. When the power-on process is completed, it turns green again.	
(7)	WLAN LED	ON (Green)	Connected to the Mesh device in MP mode.
		Blink (Green)	Not connected in MP mode.
		ON (Orange)	Connected to the Mesh device in MAP mode.
		Blink (Orange)	Not connected in MAP mode.
		Blink (Red)	DFS function is in progress.
		* Turns from Green to Red during the factory default configuration. * Blinks Green together with the STATUS LED when operating in Configuration Mode.	
(8)	STATUS LED	ON (Green)	Connected to the Mesh device. The link quality is good and communication with the Mesh device is stable.
		ON (Orange)	Connected to the Mesh device. The link quality is OK and it is possible to connect to the Mesh device.
		ON (Red)	Connected to the Mesh device. The link quality is poor and the network environment needs to be improved.
		Blink (Green)	Data communication is in progress when link quality is good.
		Blink (Orange)	Data communication is in progress when link quality is OK.
		Blink (Red)	Data communication is in progress when link quality is poor.
		* Does not blink when connection is not established. * Blinks Green together with the WLAN LED when operating in Configuration Mode.	
(9)	MAC Address	MAC Address of the LAN port on BR-400AN. The last 6-digit number is a serial number. Example) If the MAC Address is "84:25:3F:00:11:22", it would be noted as "84253F001122" and then the serial number is "001122".	

2-4. Hardware Specification

Operating environment	Temperature : 0 degrees to +40 degrees
	Humidity : 20% to 80%RH (Non-condensing)
Storage environment	Temperature : -10 degrees to +50 degrees
	Humidity : 20% to 90%RH (Non-condensing)
EMI	VCCI Class-B FCC Part15 SubPart B Class-B ICES-003 Class-B CE EN301489-1/-17 (EN55032 Class-B)
Wired network interface	10BASE-T/100BASE-TX/1000BASE-T (Auto-sensing) :1 port Auto MDI/MDIX
Wireless network interface	IEEE 802.11a/b/g/n
Channel	(US/CA) 2.4GHz: 1-11ch 5GHz: (W52) 36,40,44,48 (W53) 52,56,60,64 (W56) 100,104,108,112,116,132,136,140 (W58) 149,153,157,161,165 (EU) 2.4GHz: 1-13ch 5GHz: (W52) 36,40,44,48 (W53) 52,56,60,64 (W56) 100,104,108,112,116,120,124,128,132,136,140
Push Switch	1
LED	Top POWER (Green / Red) WLAN (Green / Red / Orange) STATUS (Green / Red / Orange)
	LAN Port Status (Orange) Link (Green)
Compatible devices	Network devices with LAN port (RJ-45)

FCC / IC Notice



FCCID : N6C-SXPCEAN2
IC : 4908A-SXPCEAN2

Channel Selection

For product available in the USA/Canada market, only channel 1~11 can be operated. Selection of other channels is not possible.

Fcc Rules Part 15

FCC CAUTION

Changes or modifications not expressly approved by the party responsible for compliance could void the user's authority to operate the equipment.

FCC Rules, Part 15 §15.19(a)(3) / IC RSS Gen §8.4

Below sentences must be indicated on the final product which contains this module inside.

This device complies with Part 15 of FCC Rules and Industry Canada licence-exempt RSS standard(s). Operation is subject to the following two conditions: (1) this device may not cause interference, and (2) this device must accept any interference, including interference that may cause undesired operation of this device.

Le présent appareil est conforme à la partie 15 des règles de la FCC et CNR d'Industrie Canada applicables aux appareils radio exempts de licence. L'exploitation est autorisée aux deux conditions suivantes : (1) l'appareil ne doit pas produire de brouillage, et (2) l'appareil doit accepter tout brouillage subi, même si le brouillage est susceptible d'en compromettre le fonctionnement.

FCC Rules Part 15 Subpart C §15.247 and Subpart E / IC RSS-102 §2.6

This equipment complies with FCC/IC radiation exposure limits set forth for an uncontrolled environment and meets the FCC radio frequency (RF) Exposure Guidelines and RSS-102 of the IC radio frequency (RF) Exposure rules. This equipment should be installed and operated keeping the radiator at least 20cm or more away from person's body.

Cet équipement est conforme aux limites d'exposition aux rayonnements énoncées pour un environnement non contrôlé et respecte les règles les radioélectriques (RF) de la FCC lignes directrices d'exposition et d'exposition aux fréquences radioélectriques (RF) CNR-102 de l'IC. Cet équipement doit être installé et utilisé en gardant une distance de 20 cm ou plus entre le radiateur et le corps humain.

FCC Rules Part 15 Subpart E §15.407(c)

Compliance with FCC requirement 15.407(c)

Data transmission is always initiated by software, which is the passed down through the MAC, through the digital and analog baseband, and finally to the RF chip. Several special packets are initiated by the MAC. These are the only ways the digital baseband portion will turn on the RF transmitter, which it then turns off at the end of the packet. Therefore, the transmitter will be on only while one of the aforementioned packets is being transmitted.

In other words, this device automatically discontinues transmission in case of either absence of information to transmit or operational failure.

FCC Rules Part 15 Subpart E §15.407(g)

Frequency Tolerance: +/-20 ppm

FCC Rules Part 15 Subpart C §15.247(g) / Subpart E

This device and its antenna(s) must not be co-located or operation in conjunction with any other antenna or transmitter.

RSS-Gen §8.3

This radio transmitter 4908A-SXPCEAN2 has been approved by Industry Canada to operate with the antenna types listed below with the maximum permissible gain and required antenna impedance for each antenna type indicated. Antenna types not included in this list, having a gain greater than the maximum gain indicated for that type, are strictly prohibited for use with this device.

Le numéro IC du présent émetteur radio 4908A-SXPCEAN2 a été approuvé par Industrie Canada pour fonctionner avec les types d'antenne énumérés ci-dessous et ayant un gain admissible maximal et l'impédance requise pour chaque type d'antenne. Les types d'antenne non inclus dans cette liste, ou dont le gain est supérieur au gain maximal indiqué pour ce type, sont strictement interdits pour l'exploitation avec cet appareil.

- Antenna type
External printed PCB antenna

- Model
H2B1PC1A1C

- Antenna Gain
2.4GHz : +1.8dBi (Peak)
5GHz : +3.9 dBi (Peak)

RSS-210

5150-5250 MHz and 5250-5350 MHz bands are restricted to indoor operations only.

High-power radars are allocated as primary users (i.e. priority users) of the bands 5250-5350 MHz and 5650-5850 MHz and that these radars could cause interference and/or damage to LE-LAN devices.

La bandes 5150-5250 MHz et 5250-5350 MHz ont restreinte à une utilisation à l'intérieur seulement.

Les radars de haute puissance sont désignés comme utilisateurs principaux (c'est-à dire utilisateurs prioritaires) pour les bandes 5250-5350 MHz et 5650-5850 MHz, et que ces radars peuvent provoquer du brouillage et/ou des dommages aux dispositifs LAN-EL.

WARNING

The FCC / The Industry Canada regulations provide that changes or modifications not expressly approved by the party responsible for compliance could void the user's authority to operate the equipment.

CE Notice



2-5. Software Specification

Normal Mode

TCP/IP	Network layer	ARP, IP, ICMP, RSTP
	Transport layer	TCP, UDP
	Application layer	HTTP, DNS client, DHCP client, NTP, FLDP, SX-SMP * FLDP, SX-SMP are the silex proprietary protocols.

Configuration Mode

TCP/IP	Network layer	ARP, IP
	Transport layer	TCP, UDP
	Application layer	HTTP, DNS(simple reply function only), DHCP (simple server function only), NetBIOS over TCP/IP (Name Service only), FLDP * FLDP is the silex proprietary protocol.

2-6. Optional Utilities

By using the following optional utilities, the Mesh network can be visualized and the time of device management can be reduced.

- AMC Manager®
- Mesh Monitor

What is AMC Manager®?

AMC Manager® is the unified device management utility that provides remote status monitoring and individual/bulk configuration for Silex devices over an IP network. If AMC Manager® is used, the BR-400AN's operating status can be shown as a list.

The screenshot displays the AMC Manager application window. The main area shows a table of detected devices, and a smaller window at the bottom shows an event log.

Group	Device Name	Ethernet Address	Host Name	IP Address	Version	Status
Detected Devices	BR-400AN	84:25:3F:01:09:E8	SX0109E8	172.25.72.100	1.2.0.1	Active
	BR-400AN	84:25:3F:01:09:F1	SX0109F1	172.25.72.101	1.2.0.1	Active
	BR-400AN	84:25:3F:01:09:F2	SX0109F2	172.25.72.102	1.2.0.1	Active
	BR-400AN	84:25:3F:01:09:F3	SX0109F3	172.25.72.103	1.2.0.1	Active
	BR-400AN	84:25:3F:01:09:F4	SX0109F4	172.25.72.104	1.2.0.1	Active
	BR-400AN	84:25:3F:01:09:F5	SX0109F5	172.25.72.105	1.2.0.1	Active
	BR-400AN	84:25:3F:01:09:F6	SX0109F6	172.25.72.106	1.2.0.1	Active
	BR-400AN	84:25:3F:01:09:F7	SX0109F7	172.25.72.107	1.2.0.1	Active
	BR-400AN	84:25:3F:01:09:F8	SX0109F8	172.25.72.108	1.2.0.1	Active
	BR-400AN	84:25:3F:01:09:F9	SX0109F9	172.25.72.109	1.2.0.1	Active
	BR-400AN	84:25:3F:01:09:FA	SX0109FA	172.25.72.110	1.2.0.1	Active
	BR-400AN	84:25:3F:01:09:FB	SX0109FB	172.25.72.111	1.2.0.1	Active
	BR-400AN	84:25:3F:01:09:FC	SX0109FC	172.25.72.112	1.2.0.1	Active
	BR-400AN	84:25:3F:01:09:FD	SX0109FD	172.25.72.113	1.2.0.1	Active
	BR-400AN	84:25:3F:01:09:FE	SX0109FE	172.25.72.114	1.2.0.1	Active
	BR-400AN	84:25:3F:01:09:FF	SX0109FF	172.25.72.110	1.2.0.1	Active
	BR-400AN	84:25:3F:01:0A:00	SX010A00	172.25.72.110	1.2.0.1	Active

Level	Date/Time	Event	Device Name	Ethernet Address	Host Name	Details
Informa...	9/11/2018 8:40:34 AM	Device detecti...	BR-400AN	84:25:3F:01:0A:00	SX010A00	Device was found.
Informa...	9/11/2018 8:40:30 AM	Device detecti...	BR-400AN	84:25:3F:01:09:FF	SX0109FF	Device was found.
Informa...	9/11/2018 8:40:28 AM	Device detecti...	BR-400AN	84:25:3F:14:09:FE	SX0109FE	Device was found.
Informa...	9/11/2018 8:40:25 AM	Device detecti...	BR-400AN	84:25:3F:01:09:FD	SX0109FD	Device was found.
Informa...	9/11/2018 8:40:24 AM	Device detecti...	BR-400AN	84:25:3F:14:09:FC	SX0109FC	Device was found.
Informa...	9/11/2018 8:40:22 AM	Device detecti...	BR-400AN	84:25:3F:01:09:FB	SX0109FB	Device was found.

1 item(s) selected.

As shown in the image below, AMC Manager® can configure IP address and write the same setting to several units at once.

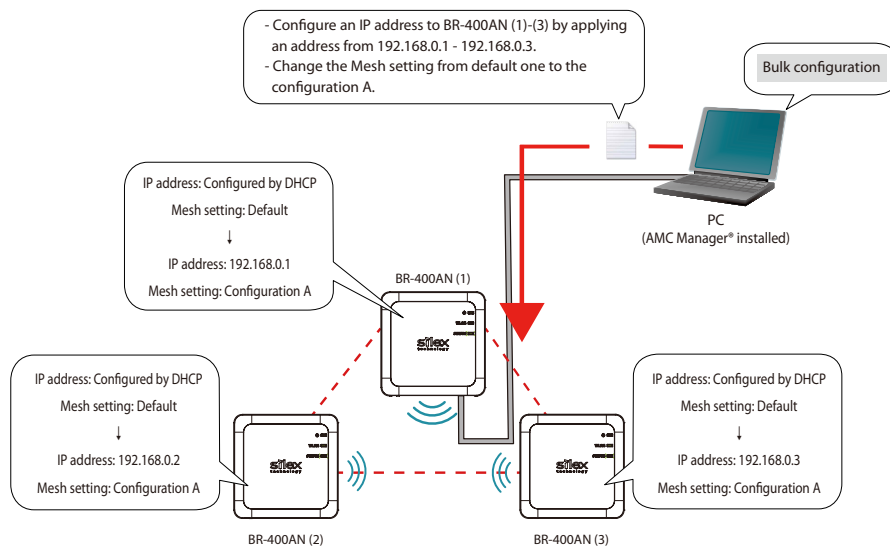

For AMC Manager®, there are a free version "AMC Manager® Free" and a non-free version "AMC Manager®". When a non-free version is used, more devices can be managed and configured at once and the plug-in utilities such as Mesh Monitor, etc. can be used.

Function	AMC Manager® Free (Free version)	AMC Manager® (Non-free version)
Number of controllable devices	Up to 10 devices	Up to 10,000 devices
Number of devices that can be controlled at a time	Up to 10 devices	Up to 10,000 devices
Number of groups that can be created	Up to 2 devices	Up to 100 devices
Number of devices that can be registered per group	Up to 10 devices	Up to 1,000 devices
Plug-in utility such as Mesh Monitor	Unavailable	Available



- To use AMC Manager® (non-free version), the license key needs to be purchased.
- If you are interested in purchasing the license, please contact us. For the contact information, refer to **1-3. User Registration and Customer Services - Customer Support Center.**

What is Mesh Monitor?

Mesh Monitor is a non-free plug-in utility of AMC Manager®.

Mesh Monitor can visualize the route setting and operating status to support the Mesh network management.

Actual environment

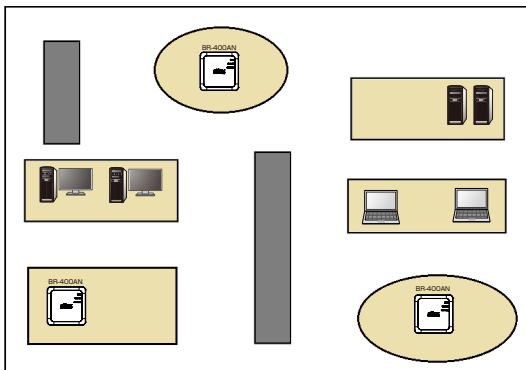

Display on Mesh Monitor

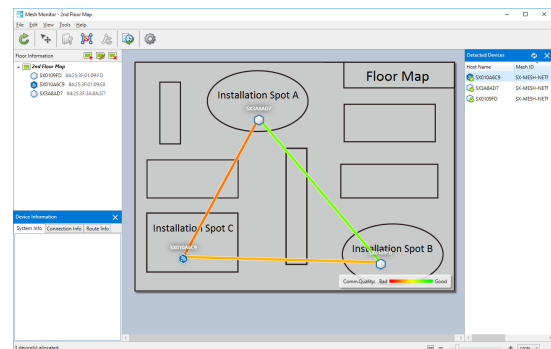

As shown in the image above, the actual installation environment is simulated on Mesh Monitor. The route information is displayed based on the actual route setting of BR-400AN. It is possible to change some functions of BR-400AN using Mesh Monitor (e.g. enabling/disabling Access Point function, etc.). Also, a history of Mesh network route and BR-400AN's operating status can be checked and which can be used conveniently for troubleshooting.



TIP

- Mesh Monitor does not come with AMC Manager®.
- Mesh Monitor is a non-free plug-in utility of AMC Manager®. To install it, another license key needs to be purchased.
- If you are interested in purchasing the license, please contact us. For the contact information, refer to **1-3. User Registration and Customer Services - Customer Support Center**.

2-7. Wireless Interference Information

Notes of Use

Do not use BR-400AN near the following devices or places.

- Microwave, pacemaker, etc. of industrial, scientific and medical devices
- Licensed radio station in a factory
- Small power radio station (A non-licensed radio station)

These devices may use the same band. If you use BR-400AN near these devices, the radio waves emitted from BR-400AN may interfere with them.

Do not use BR-400AN near a cellular phone, TV or Radio.

A cellular phone, TV and radio use a different radio band than our products. Generally, if they are used near BR-400AN, it will not cause any problems. However, when they approximate BR-400AN, sound or image noise may occur.

If there is reinforced concrete/metal between wireless devices, they may not connect.

BR-400AN can connect through wood or glass, but may have troubles connecting through reinforced concrete/metal.

BR-400AN complies with the certification of conformance to technical standards. Please pay attention to the following points:

- Please do not disassemble or remodel the product. Such action is prohibited by law.
- Please do not remove the certificate label. Using the product without a label is prohibited.

Wireless devices using 2.4GHz band

The same frequency band of BR-400AN is used for a microwave, industry, science, medical equipment and licensed in room or low power (non-licensed) radio stations.

- Before you use BR-400AN, check that it does not interfere with other devices.
- If interference occurs, stop using BR-400AN or change the wireless band. Please consider to create a wall between these devices to avoid interference. Contact us to for possible solution.

*The meaning of the symbols in the bottom of the unit:

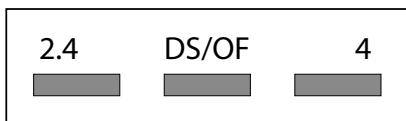

2.4	: Wireless devices using 2.4GHz frequency band
DS/OF	: DS-SS or OFDM is used as modulation.
4	: The range of interference is equal to or lower than 40m.
	: All bands can be used to avoid interference.

Notes on using 5GHz band

Use of 5.2GHz band (W52) and 5.3GHz band (W53) outdoors is prohibited by the radio law. When BR-400AN is used outdoors, use W56 channels only and do not use W52/W53 channels.

DFS

BR-400AN supports DFS (Dynamic Frequency Selection) of the IEEE 802.11h wireless standard. When radar signals are detected, the channel will automatically be switched to avoid interference with radar systems (e.g. weather radar, etc).

One alternative channel can individually be set for W53/W56 channels beforehand, which will be used when radar signals are detected and the channel needs to be switched.

When alternative channels are not specified or radar signals are detected even for that channel, the channel is randomly is changed.



- If **Use DFS Band** is **ON**, the DFS channels can be used (it is set to **OFF** by default).
- When BR-400AN is started with a DFS channel, it checks if there are radar signals on that channel. During such a period, BR-400AN is unable to communicate.
- If radar signals are detected during or after BR-400AN is powered on, the channel needs to be changed in order to avoid wireless interference. Therefore, if DFS channels are selected, the channel could be changed automatically.
- The radar signals are monitored for a certain amount of time (*) after it is detected, while wireless communication is disabled on BR-400AN then. Once radar signals are detected, the channel will not be available for 30 mins. (*This time period differs depending on the country.)
- If radar signals are detected when they are monitored, the channel is switched to CH36. If radar signals are not detected by MP/MAP, a scan is handled on CH36. When connectable MP/MAP are found, the channel is switched to CH36. When it is not found, the same channel is used. This operation is processed only when the channel is W53.
- When the channel is switched after radar signals are detected, the destination channel is notified to the adjacent MP/MAP. MP/MAP switches the channel when it receives the notification.

2-8. Notes on Security

Because a wireless LAN uses electromagnetic signals instead of a network cable to establish communication with network devices, it has the advantage of allowing devices to connect to the network easily. However, a disadvantage of this is that within a certain range, the electromagnetic signals can pass through barriers such as walls, and if security countermeasures are not implemented in some way, problems such as the following may occur.

- Communication is intercepted by a third party
- Unauthorized access to the network
- Leakage of personal information (ID and Card information)
- Spoofing and the falsification of intercepted data
- System crashes and data corruption

Nowadays, wireless LAN cards or access points are equipped with security measures that address such security problems, so that you can enable security-related settings for wireless LAN products in order to reduce the likelihood of problems occurring.

We recommend that you make yourself fully acquainted with the possible implications of what might happen if you use a wireless product without enabling security features, and that you configure security-related settings and use wireless products at your own responsibility.

2-9. Restrictions

BR-400AN has the following restrictions.

Restrictions on DFS Channels

- If radar signals are detected again during the radar monitoring period that occurs as a result that radar signals are found when BR-400AN is started or operating (*), BR-400AN may not be able to join the network of adjacent MP/MAP.
- For some wireless environments, even if the destination channel is notified to the adjacent MP/MAP, the channel switch may not perform as the notification is not received correctly.
- If BR-400AN is restarted after it detected radar signals and switched the channel, BR-400AN starts with the pre-configured channel NOT with the channel it switched. If the channel is different from the adjacent MP/MAP, BR-400AN will not be able to join the same network.

(* This time period differs depending on the country.)

3. How to Install BR-400AN

This chapter provides the notes and examples of installation.

3-1. How to Install BR-400AN

The wireless distance, installation method and power-on method are explained.

Product Installation and Radio Distance

BR-400AN radiates radio waves. Make sure that the top surface of BR-400AN (the surface with Silex logo and LEDs) face a target device.

As a wireless communication distance is set to approximately 20m by defaults, place the target device within that range. The height of installation position must be about 2m from the ground.

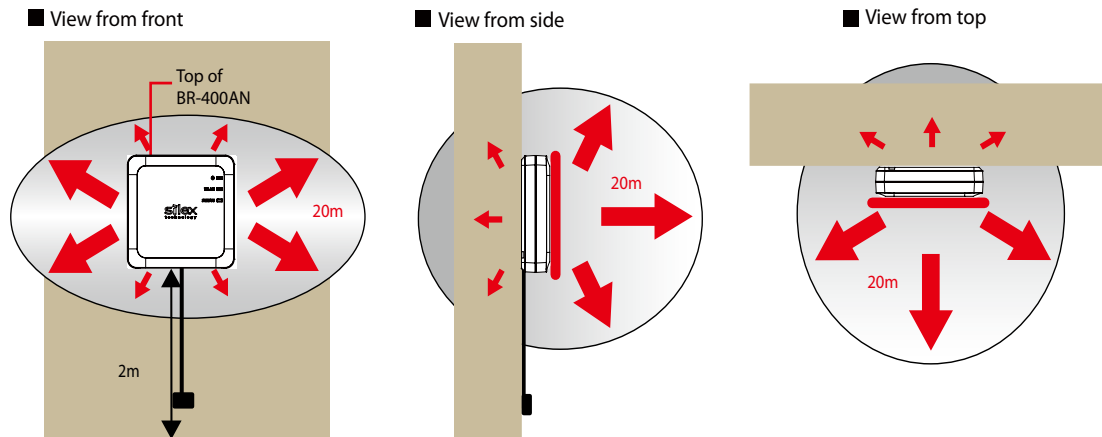

- An actual wireless communication distance may vary depending on wireless signal status on your environment.



Note

- By changing the transmission power setting on BR-400AN, the wireless communication distance can be expanded / shortened. For details, refer to **5-1. Configuration Items on BR-400AN's Web Page - Option Configuration page.**

How to Turn on BR-400AN

Below explains how to turn on BR-400AN and how the LED lights when BR-400AN is operating correctly.

1. Connect the AC adapter to BR-400AN (1) and the AC plug to outlet (2).

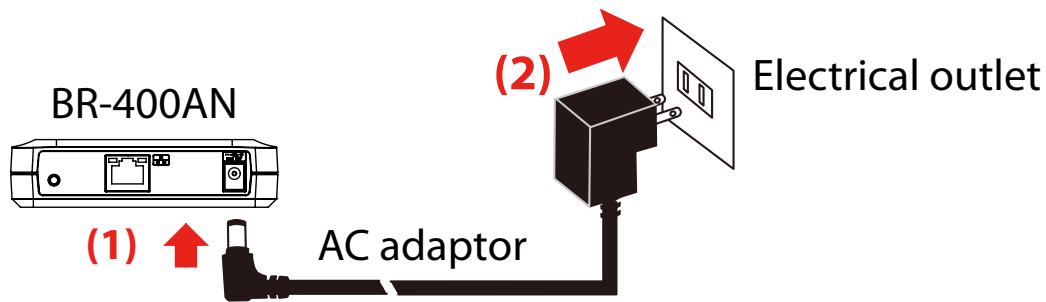

2. When BR-400AN is started, the LED turns on or blinks as shown at (1).
When the Mesh network is configured, the LED turns on or blinks as shown at (2)(3)(4).

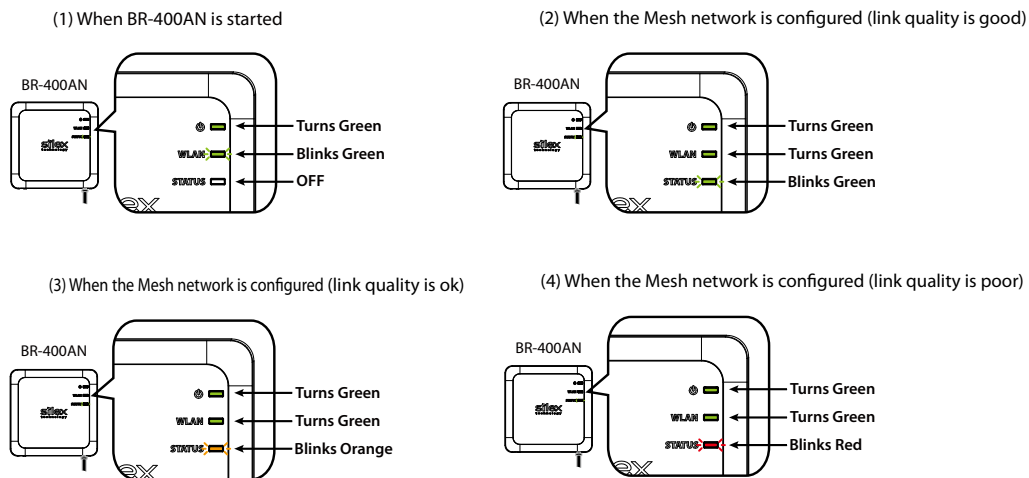

Note

- When BR-400AN is operating in MAP mode, the WLAN LED turns or blinks orange.
- To improve a link quality, confirm the followings and change the location of installation if necessary.
 - No reinforcing bars, metal and concrete walls or poles are installed in front of the radio emission portion.
 - Not too far away from the other BR-400AN units
 - The bottom surface of BR-400AN is not facing a concrete wall.

3-2. Example of Installation

BR-400AN can configure various types of the Mesh network by changing the combination of settings and devices.

In this section, some examples of typical installation are introduced.

See the example that best matches your environment to install BR-400AN.

- When the Mesh network is established using BR-400AN only
- When BR-400AN is connected to your existing network
- When the Mesh network is divided for each area
- When tablet devices or PCs are connected wirelessly

Configuring Mesh network using BR-400AN only

The following is a sample configuration image for the Mesh network using BR-400AN only without using the existing network.

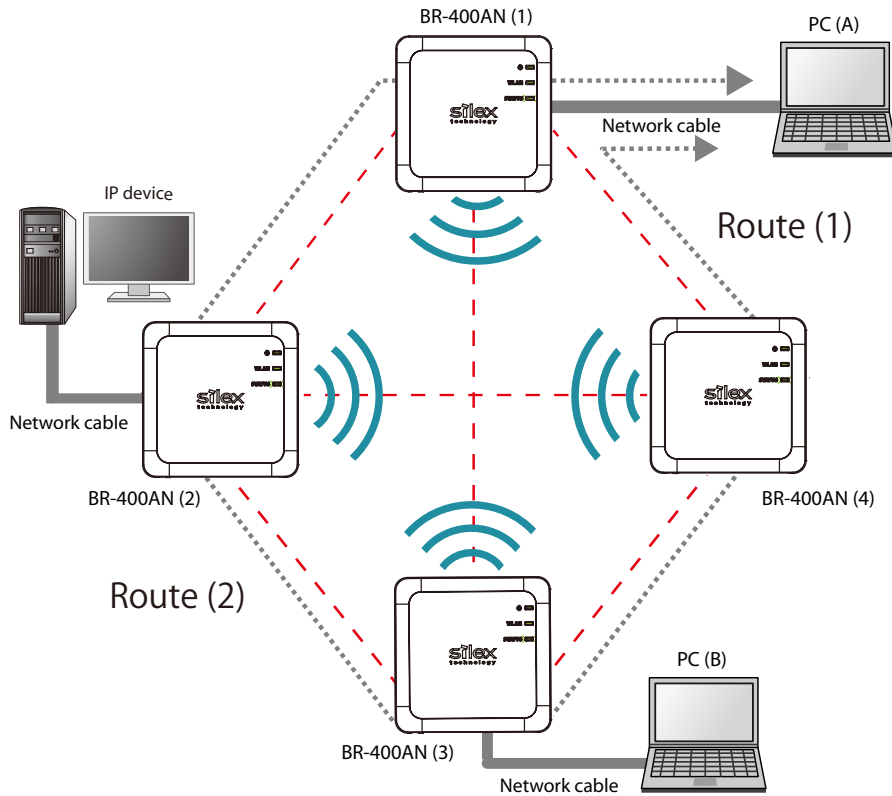

Note

- The sample network above can be configured by default setting.
- If a valid IP address has already been configured to each device and they can communicate among each other, you do not have to install a new DHCP server to configure the Mesh network.
- As long as a valid IP address is configured, PC (A), PC (B) and IP device can communicate with each other.
- As shown in above image, even if an error occurs to BR-400AN (4) and the route (1) becomes unavailable, the devices will continue to communicate through the route (2).
- The communication speed can be improved by selecting **DISABLE** for **Avoid Network Loop** on all BR-400AN units.

Connecting BR-400AN to your existing network

The following is a sample configuration image for the Mesh network when adding multiple BR-400AN units to your existing network.

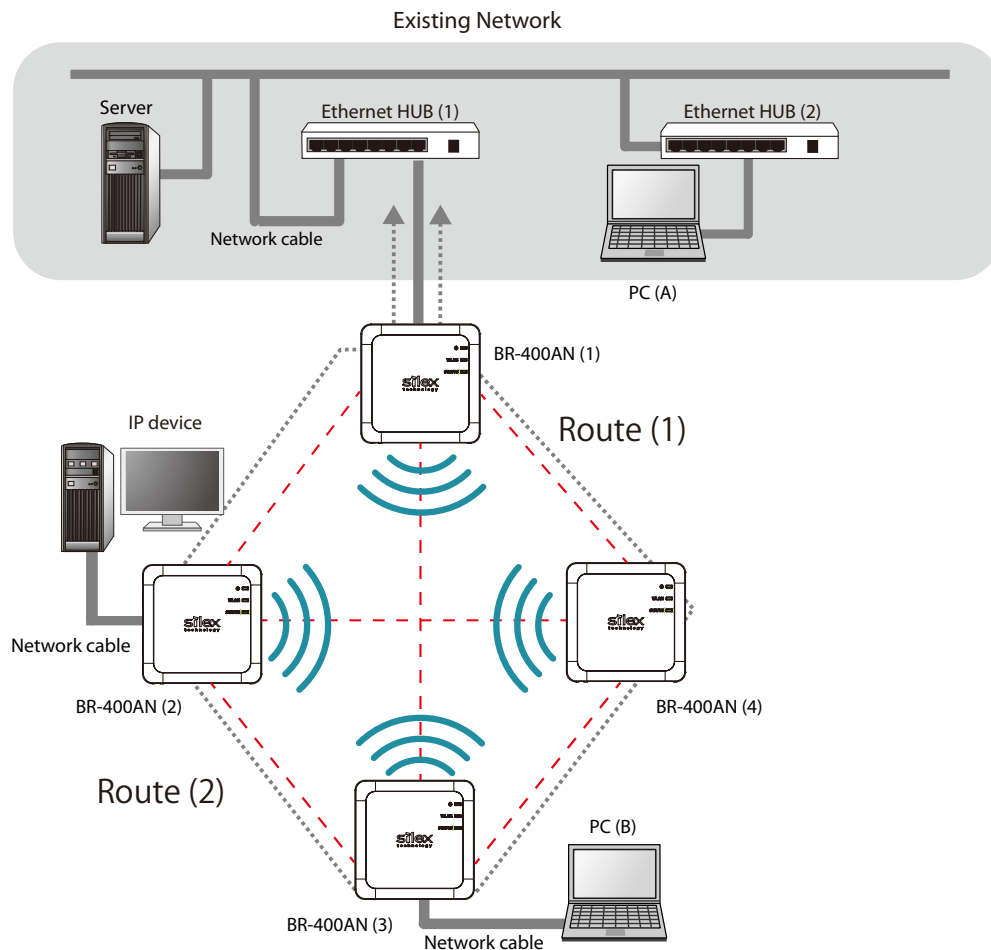

- When 2 or more BR-400AN units are connected to the same existing network via wired LAN, **Avoid Network Loop** must be set to **ENABLE** (by default, this setting is enabled).



Note

- The sample network above can be configured by default setting.
- If a valid IP address has already been configured to each device and they can communicate among each other, you do not have to install a new DHCP server to configure the Mesh network.
- As long as a valid IP address is configured, PC (A), PC (B) and IP device can communicate with each other.
- As shown in above image, even if an error occurs to BR-400AN (4) and the route (1) becomes unavailable, the devices will continue to communicate through the route (2).
- The communication speed can be improved by selecting **DISABLE** for **Avoid Network Loop** on the BR-400AN units (2)-(4).

Dividing the Mesh network for each area

The Mesh network can be configured separately for each section of the area where BR-400AN units are installed. The following is the example of how to configure the Mesh network for each section. For this, Mesh ID and Mesh encryption key need to be changed for each area.

For details, refer to **5-1. Configuration Items on BR-400AN's Web Page - Basic Configuration** page.

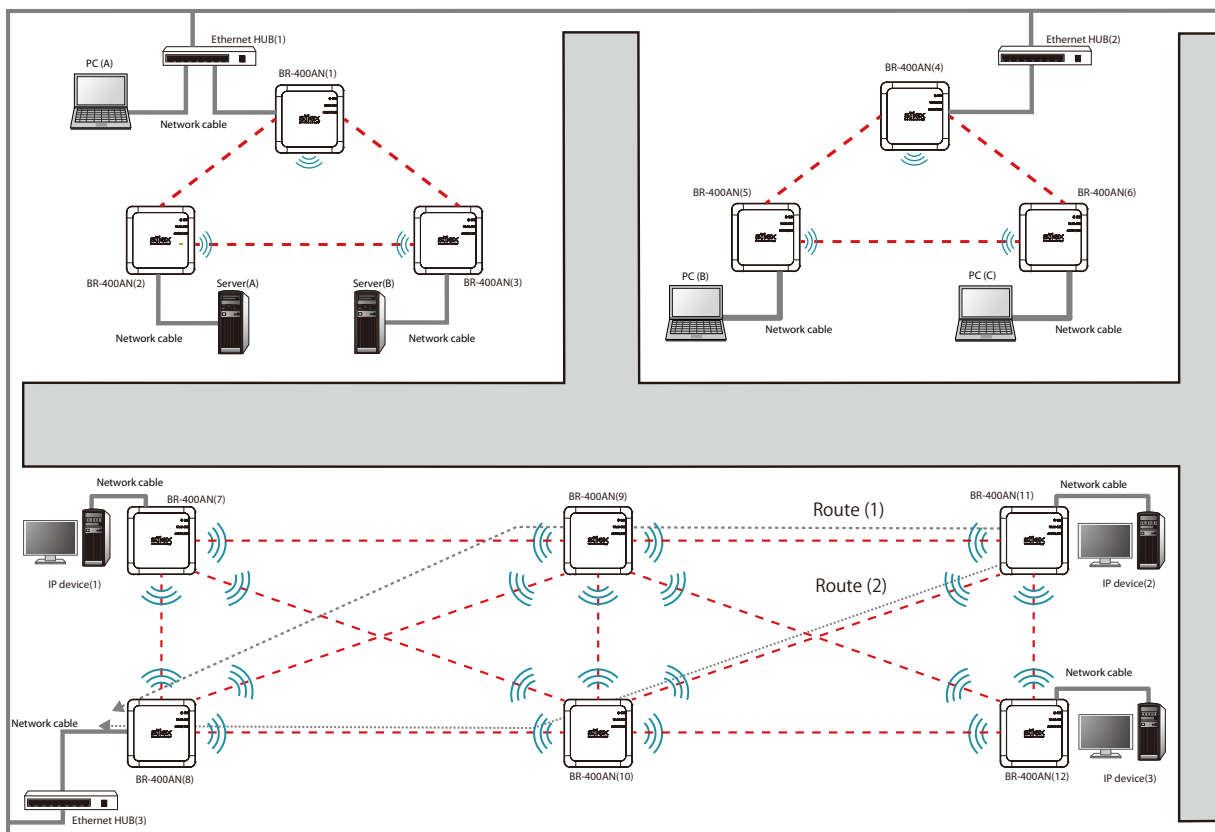

- When 2 or more BR-400AN units are connected to the same existing network via wired LAN, **Avoid Network Loop** must be set to **ENABLE** (by default, this setting is enabled).



Note

- If a valid IP address has already been configured to each device and they can communicate among each other, you do not have to install a new DHCP server to configure the Mesh network.
- As long as a valid IP address is configured, each PC, server and IP device can communicate with each other.
- As shown in above image, even if an error occurs to BR-400AN (9) and the route (1) becomes unavailable, the devices will continue to communicate through the route (2).
- The communication speed can be improved by selecting **DISABLE** for **Avoid Network Loop** on the BR-400AN units which are not connected to the Ethernet HUB.

Connecting tablet devices or PCs wirelessly

By using the Access Point function of BR-400AN, wireless client devices (PC, tablet device, etc.) can be connected to the Mesh network.

For details on how to enable the Access Point feature of BR-400AN and connect wireless client devices, refer to **6. How to Connect Wireless Client Devices**.

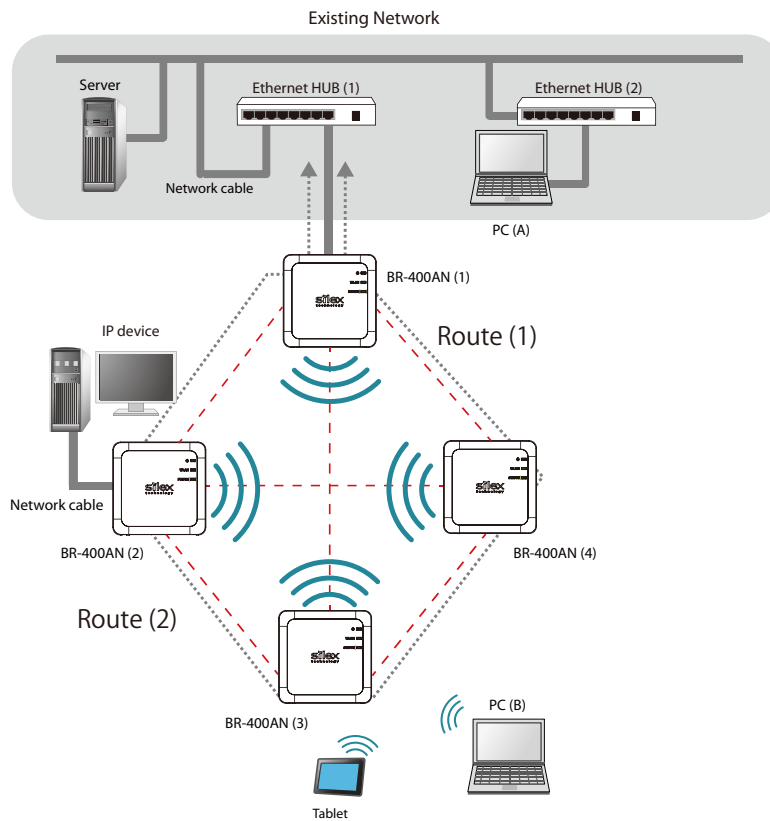

- When 2 or more BR-400AN units are connected to the same existing network via wired LAN, **Avoid Network Loop** must be set to **ENABLE** (by default, this setting is enabled).



Note

- If a valid IP address has already been configured to each device and they can communicate among each other, you do not have to install a new DHCP server to configure the Mesh network.
- As long as a valid IP address is configured, PC (A), PC (B), tablet device and IP device can communicate with each other.
- As shown in above image, even if an error occurs to BR-400AN (4) and the route (1) becomes unavailable, the devices will continue to communicate through the route (2).
- The communication speed can be improved by selecting **DISABLE** for **Avoid Network Loop** on the BR-400AN units (2)-(4).

4. How to Configure BR-400AN

This chapter explains how to configure BR-400AN.

The following configuration methods are available:

- 1) Configuration via the BR-400AN's Web page
- 2) Configuration using AMC Manager®
- 3) Configuration using Mesh Monitor

4-1. Configuration via BR-400AN's Web Page

Below explains how to configure BR-400AN via its Web page.

If you know the IP address of BR-400AN, the Web page can be accessed by entering the IP address to the address bar of Web browser. If you do not know the IP address, the Web page can be accessed by starting BR-400AN in configuration mode.

Accessing the BR-400AN's Web Page Using Configuration Mode

How to access the BR-400AN's Web page using the configuration mode is explained.

1. Connect BR-400AN and the PC using a network cable (1) and turn on BR-400AN (2)(3).

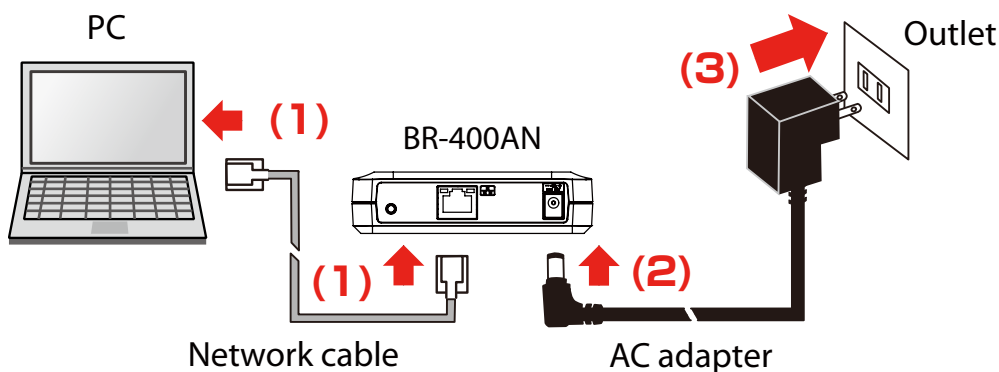

- 2.** On top surface of BR-400AN, check that the POWER LED turns green and the WLAN LED turns or blinks green/orange (1). Push and hold the push switch on the front surface (2). When the POWER LED turns red and the WLAN LED and the STATUS LED start to blink green together (3), release the push switch (4) (it may take 20 sec until both LEDs start to blink).

BR-400AN will start to run in a configuration mode and configuration will become available on the PC that has been connected to BR-400AN using the network cable.

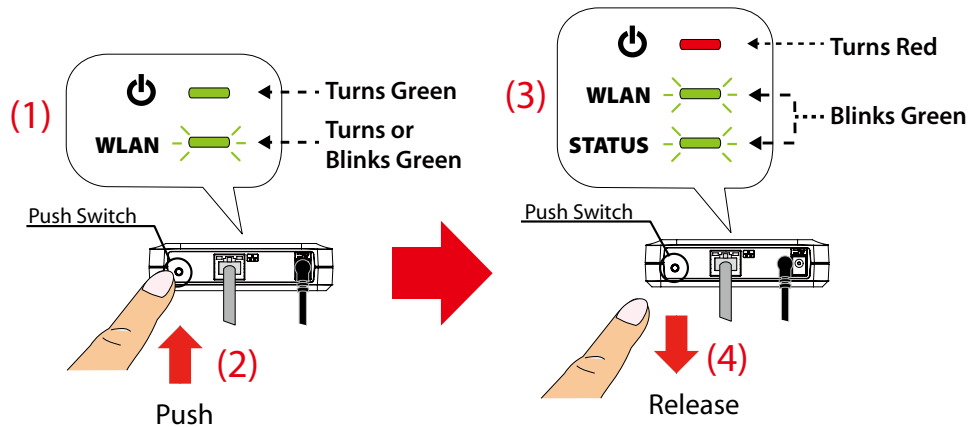

- When BR-400AN is started, only the POWER LED turns green for 2 sec and then turns off. If the push switch is pushed then, BR-400AN is not started in the configuration mode.
- Before you push the push switch, check that the POWER LED turns green and the WLAN LED turns or blinks green/orange.

3. Start a Web browser on the PC. When the login password configuration page appears, enter the password to configure for BR-400AN and click **Submit**.



TIP

- The login password configuration page is displayed only when BR-400AN is configured for the first time.



Note

- If the login password configuration page is not displayed even though the password is set to BR-400AN, enter "**http://silex**" in the address bar of the Web browser and press the **Enter** key.

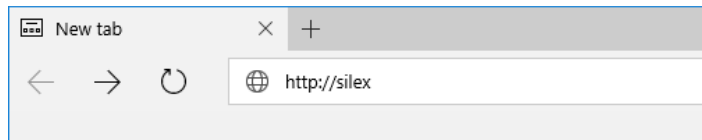

4. The login page of BR-400AN is displayed.
Enter the password of BR-400AN and click **Login**.

Accessing BR-400AN's Web Page over Network

If you know the IP address of BR-400AN, BR-400AN does not need to be started in the configuration mode. Access the BR-400AN's Web page from your PC and change the configuration from the Web page.

1. Start a Web browser (Edge, Internet Explorer, Google Chrome, etc.) on the PC and enter the IP address of BR-400AN to the address bar of the Web browser.

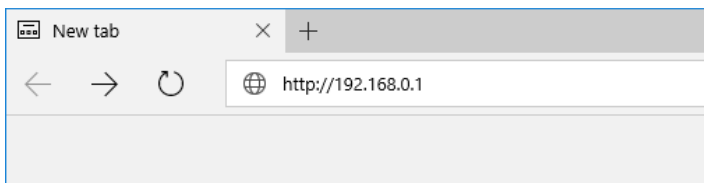

2. When the login password configuration page appears, enter the password to configure for BR-400AN and click **Submit**.

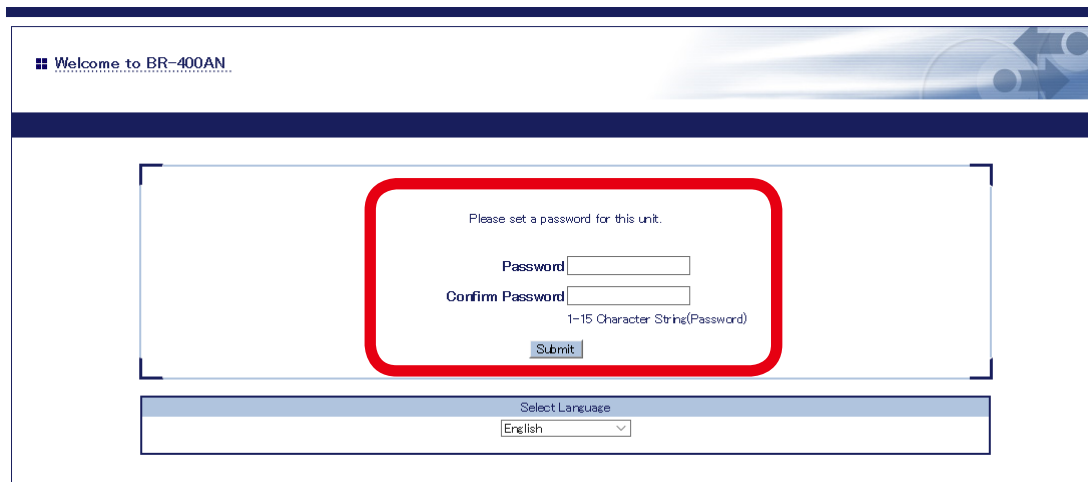
A screenshot of the BR-400AN web interface. At the top, it says 'Welcome to BR-400AN'. The main content area contains a red-bordered box with the text 'Please set a password for this unit.' Below this are two input fields: 'Password' and 'Confirm Password'. Under the 'Confirm Password' field, it says '1-15 Character String(Password)'. A 'Submit' button is located below the input fields. At the bottom of the page, there is a 'Select Language' dropdown menu currently set to 'English'.

TIP

- The login password configuration page is displayed only when BR-400AN is configured for the first time.

3. The login page of BR-400AN is displayed.
Enter the password of BR-400AN and click **Login**.

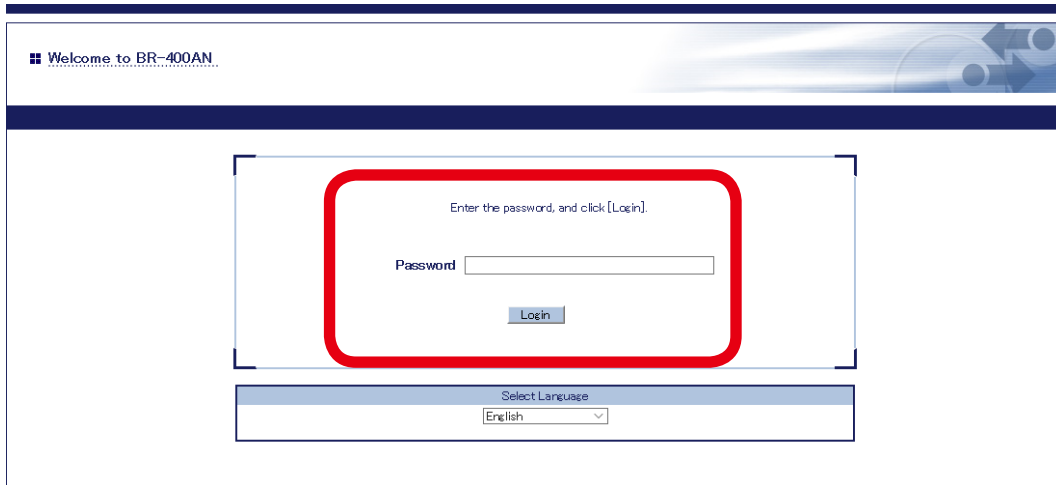

Configuration via BR-400AN's Web Page

When the login password authentication is successfully finished, the window below is displayed. When the login password is not set, the login page is skipped and the window below is immediately displayed.

The screenshot shows the 'Basic Configuration' page of the BR-400AN web interface. The page is titled 'Basic Configuration' and includes a navigation menu on the left and a main configuration area. Red callouts are placed as follows:

- (1) Points to the 'System Configuration' menu item in the left sidebar.
- (2) Points to the 'Basic Configuration' tab at the top of the main content area.
- (3) Points to the main configuration area containing sections for Host Name, IP Address Configuration, DNS Configuration, and Mesh General Configuration.
- (4) Points to the 'HELP' button in the top right corner.
- (5) Points to the footer area containing the 'silex BR-400AN Ver 1.2.0 [8425.3f00:1122]' information.

This is a close-up view of the bottom portion of the web page. Red callouts are placed as follows:

- (5) Points to the footer area containing the 'silex BR-400AN Ver 1.2.0 [8425.3f00:1122]' information.
- (6) Points to the 'Submit' button.
- (7) Points to the 'Reset' button.

(1) Menu

If clicked, the configuration page is changed.

(2) Tab

The tab is displayed when there are multiple pages for the configuration. If the tab is clicked, the configuration page is changed.

(3) Configuration page

Each setting can be configured.

(4) Link to Help

The Help page is displayed. The Help page provides the detailed explanation of each setting.

(5) Firmware version / MAC address

The firmware version and MAC address of BR-400AN are displayed.

(6) Submit (Save) button

If clicked, the changes you made to the configuration page will be saved. (You may need to scroll-down the screen to find this button.)

(7) Clear button

If clicked, the changes you made to this configuration page will be cleared. (You may need to scroll-down the screen to find this button.)



TIP

- Be sure to change the password when BR-400AN is connected to a public network.
- Be sure to use encryption when the Access Point feature of BR-400AN is used.
- The wireless bands of IEEE 802.11b/g and IEEE 802.11n/b/g are often in use by someone as a large number of wireless devices are using that bands. In such a case, you may not be able to procure enough communication bands for your use.
- Follow the radio law of your country when BR-400AN is used outdoors. There are restrictions on the communication bands (channels) that you can use outdoors.
- When W53(52/56/60/64ch) or W56(100/104/108/112/116/120/124/128/132/136/140ch) is selected, you may need to refer to the restrictions at **2. Specifications - 2-7. Wireless Interference Information - DFS**.

1. Select the configuration page by clicking the menu or tab and enter the necessary settings. Click **Submit** when finished.

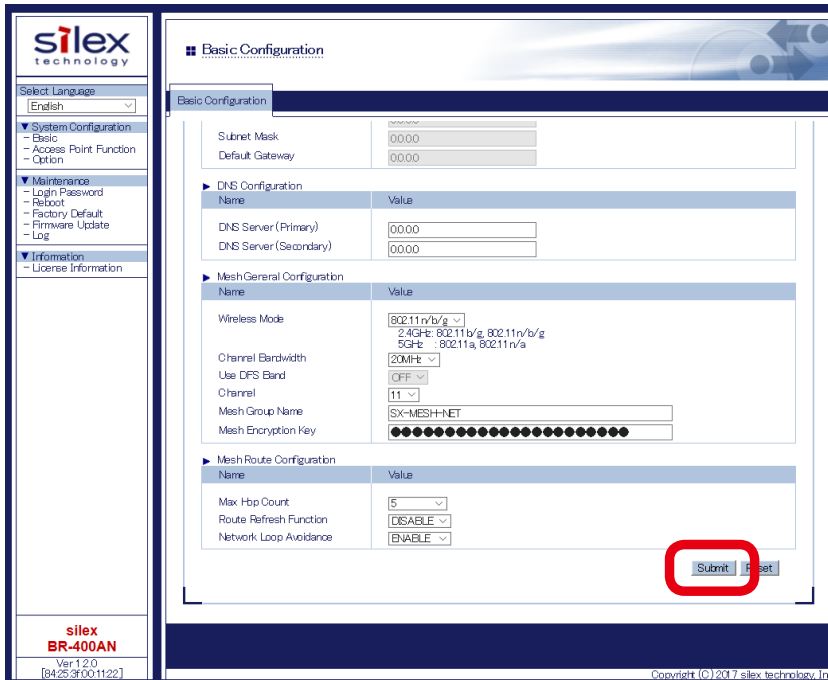

Note

- For details on each configuration item, refer to **5. List of Configuration Items**.

2. The message below is displayed.
Repeat **1** to continue the configuration.

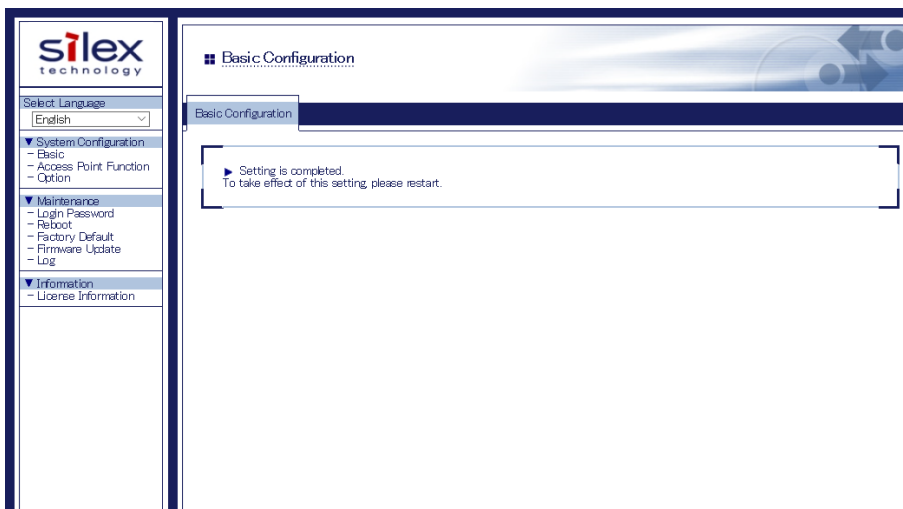

3. When the configuration is completed, restart BR-400AN.
Click **Restart** from the menu (1) and Click **Yes** (2).

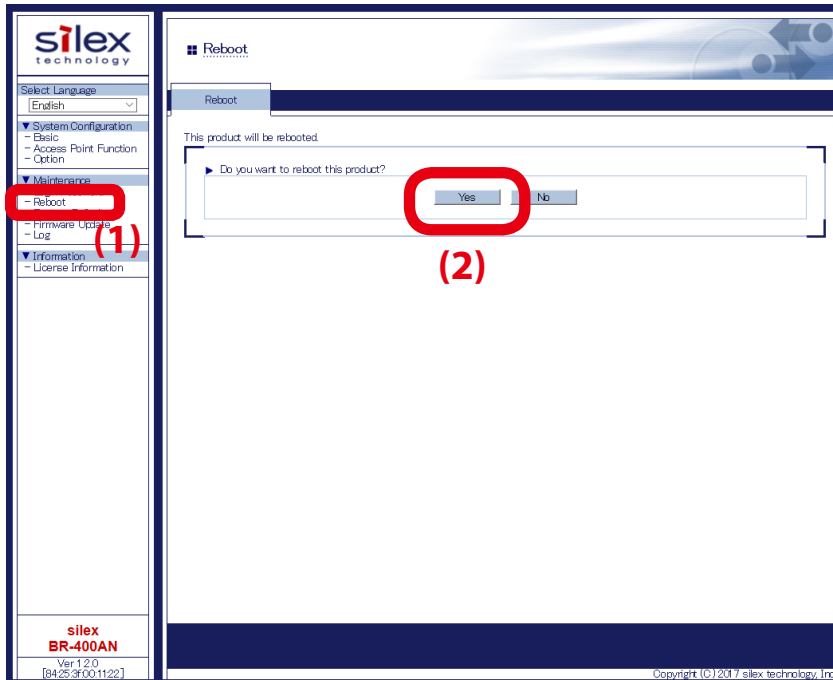

4. BR-400AN is restarted.
When the progress bar reaches the right end of the screen, the restart is completed.
Finish the Web browser then.

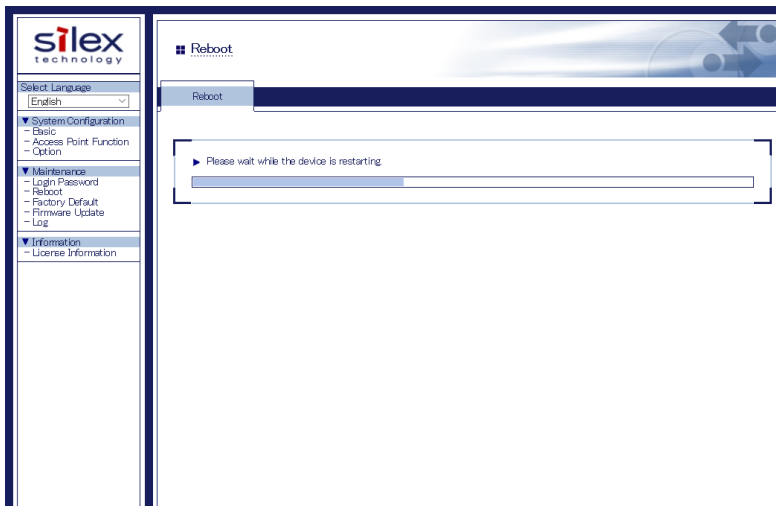

4-2. Bulk Configuration Using AMC Manager®

If the unified device management software AMC Manager® is used, several BR-400AN units can be configured at once. The bulk configuration method is explained.



- For details on AMC Manager®, refer to the AMC Manager® User's Manual.

Note

Preparation for Bulk Configuration

Create a configuration file for bulk configuration using AMC Manager®. To create the configuration file, following items are necessary.

- PC (AMC Manager® needs to be installed)



- When the login password is not set to a device, please include that setting to the configuration file. If the login password is not set, the bulk configuration does not perform correctly.

TIP

1. Start AMC Manager® on the PC.

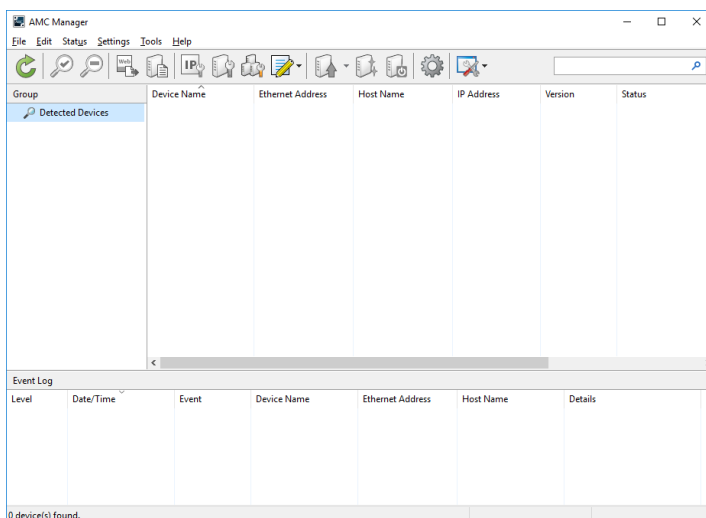

- From the toolbar, click the icon **Create the configuration file** and select **Create from Template**.

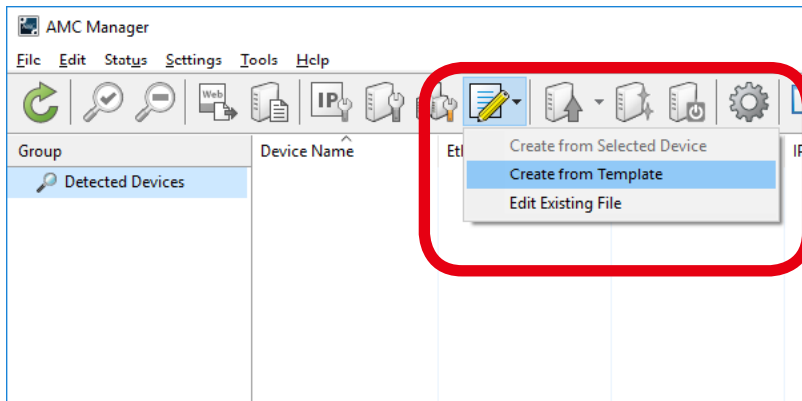
**Note**

- It is possible to read the setting from the configuration file if there is the one created in the past. For such a case, click the icon **Create the configuration file** and select **Edit Existing File**.

- Select a template file for BR-400AN (1) and click **OK** (2).

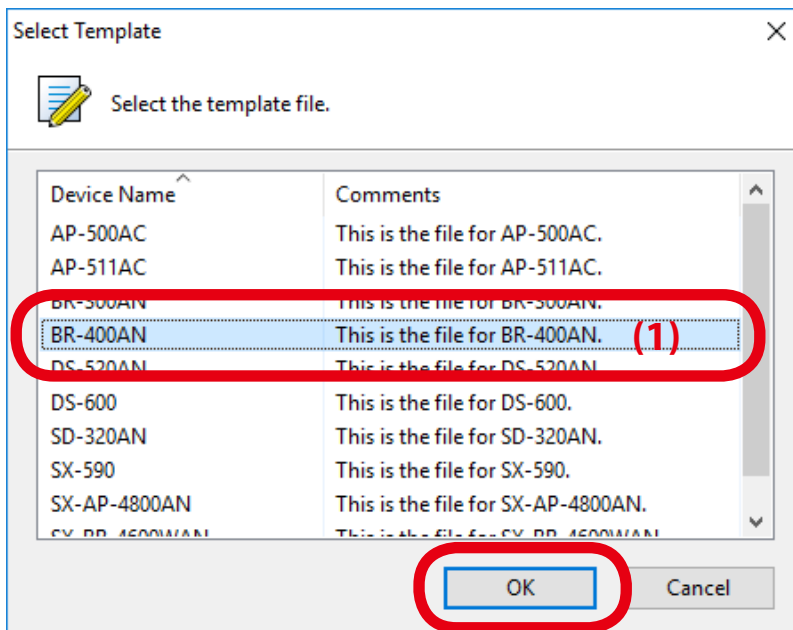
**(2)**

4. If a configuration category is clicked on the left side of the screen (1), the corresponding setting is displayed on the right side (2).

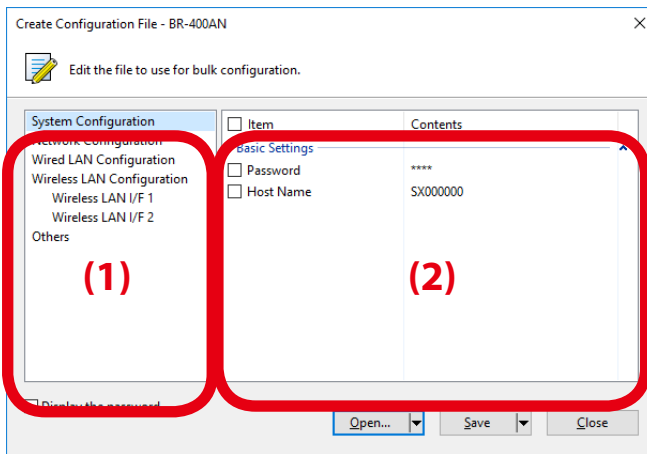

5. Check the check boxes of the settings to configure and edit them (1). When finished editing the necessary settings, click **Save** (2).

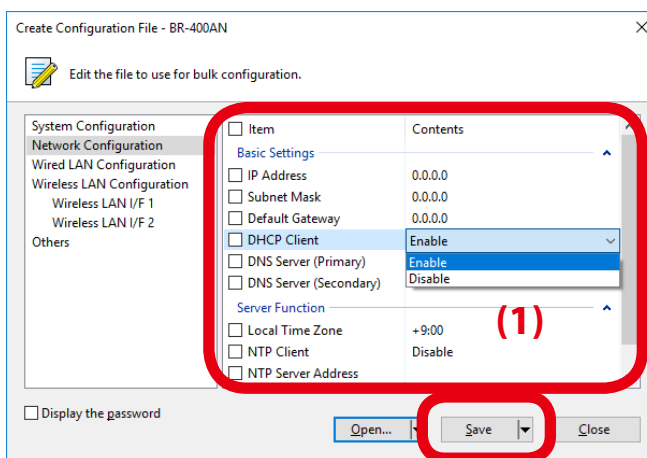

TIP

- If an IP address is specified in the configuration file, such address will be configured to all devices when the same configuration file is used for them. Clear the check box of IP address to avoid it.
- There is a combination of the settings unable to write into BR-400AN units. Below is the example.
 - Wireless mode is set to 802.11n/b/g or 802.11n/a while WEP is enabled.
 - WEP is enabled and incompatible number of characters are used to specify WEP key.
- For other examples, refer to **A-1. Troubleshooting**.

**Note**

- The setting whose check box is checked will be configured to BR-400AN. For the setting you do not want to change, clear the check box.
- It is recommended to set/change the password to protect the setting information.
- Please be careful not to forget the **Password, Mesh Group ID, Mesh Encryption Key, SSID, Security Key (WEP Key or Pre-Shared key)** to configure.
- It is possible to configure an IP address to several devices at once using AMC Manager®.

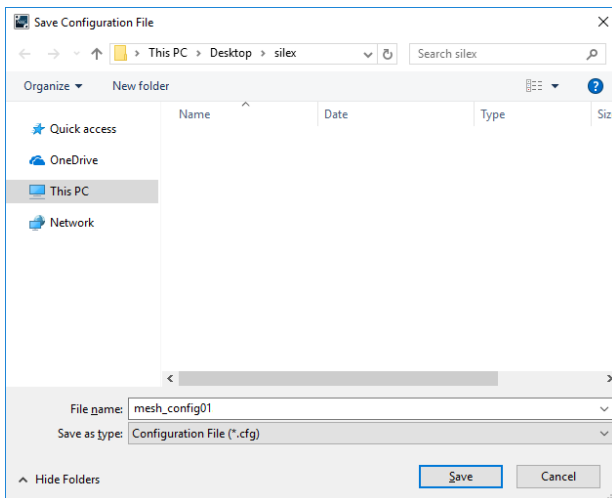
6. Specify a file name to save the configuration file.

After the configuration is saved, the screen of **4** is displayed again.

To create a configuration for each Mesh network group, repeat **4-6**.

When the configuration file is created, the preparation for bulk configuration is completed. Click **Close** then.

Starting Bulk Configuration

Multiple BR-400AN units can be configured at once using the configuration file that you have created at **Preparation for Bulk Configuration**.

For bulk configuration, following items are required.

- PC (AMC Manager® needs to be installed)
 - Network cable
1. For the bulk configuration of IP address, the IP address of the PC needs to be changed beforehand. Change the IP address of the PC to the one that can be communicated with BR-400AN units after the bulk configuration.

Sample Setting)

Sample IP address setting for bulk configuration	Sample IP address setting for PC
192.168.0.10 - 192.168.0.30	192.168.0.100
172.25.10.10 - 172.25.10.25	172.25.10.100



- The bulk configuration of IP address can be used for initial configuration.

TIP

2. Turn on all BR-400AN units to configure, and connect a PC to one of them.

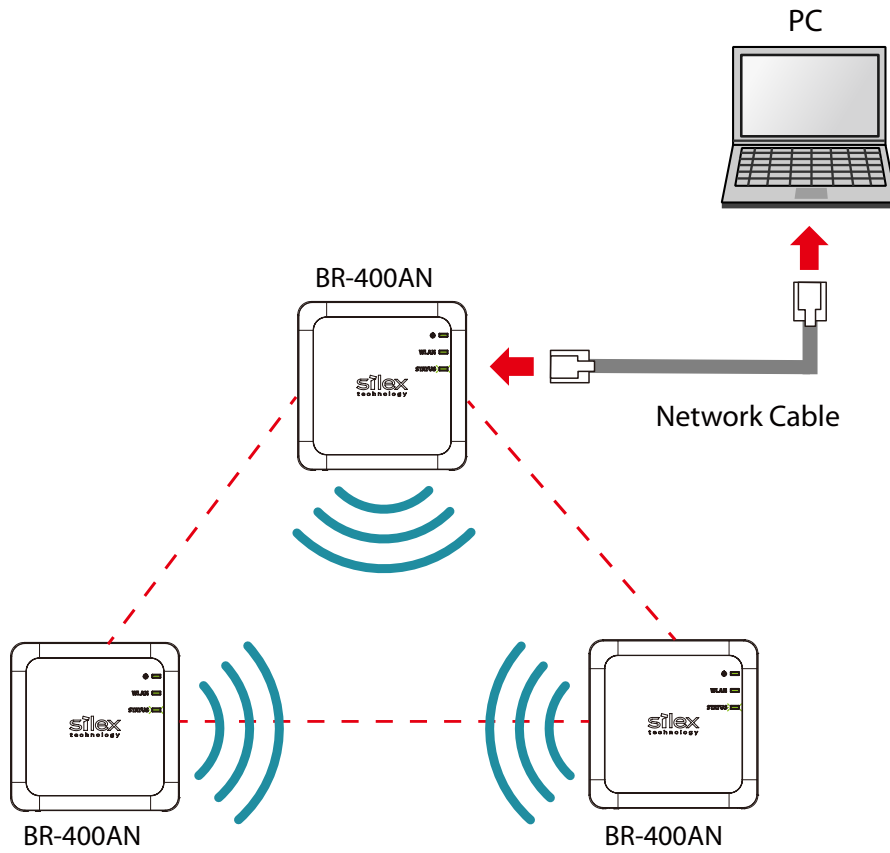

- The BR-400AN units to configure should temporarily be placed in a close location to configure the Mesh network.
- Finish the bulk configuration before actual use of BR-400AN.

3. Start AMC Manager® on the PC.

BR-400AN units are displayed on the device list when they are active on the Mesh network.

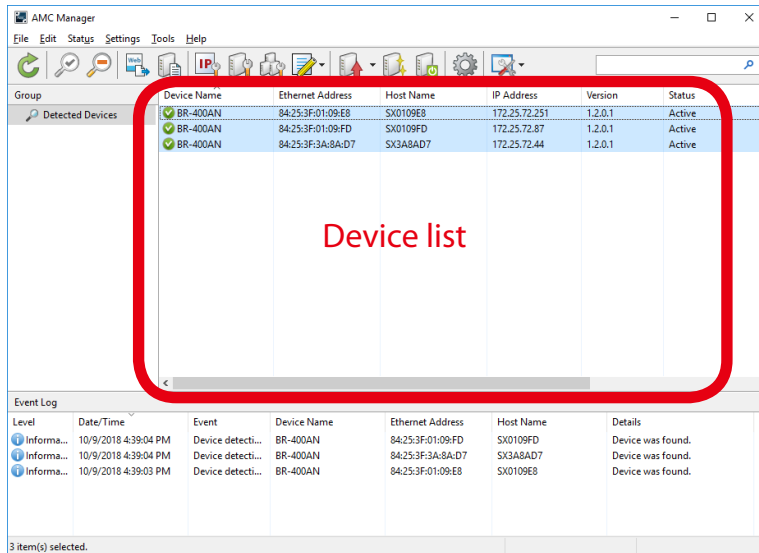

- If the BR-400AN units are not displayed on the device list, click the icon **Refresh**.
- It may take approximately 1 min to show them on the device list depending on your environment.

Note

4. Select the BR-400AN units to configure at once (1) and click the icon **Configure multiple devices in bulk** (2).

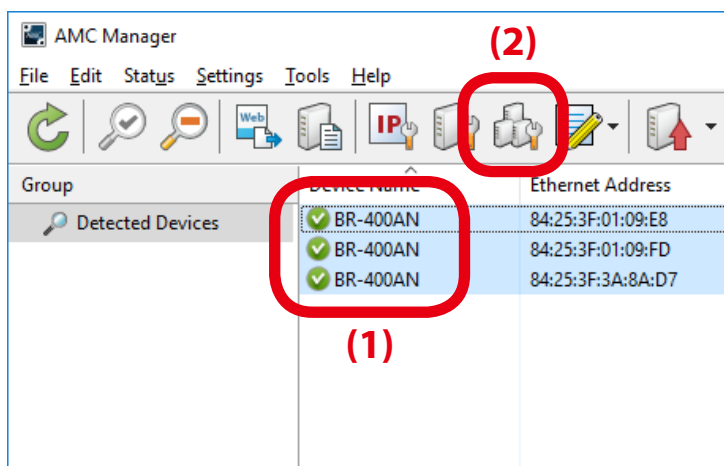

5. Specify the configuration file. Select BR-400AN units to configure (1) and click **Select Config. File** (2).

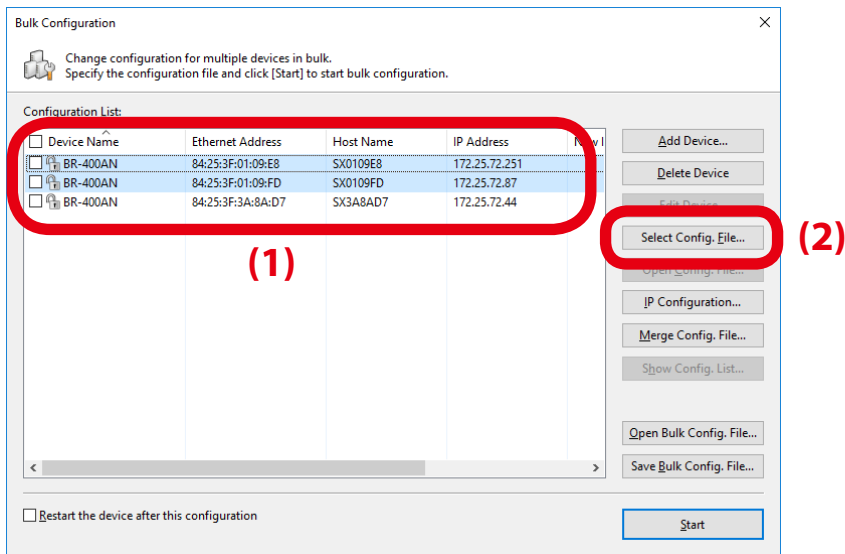

6. Select the configuration file that you have created beforehand.

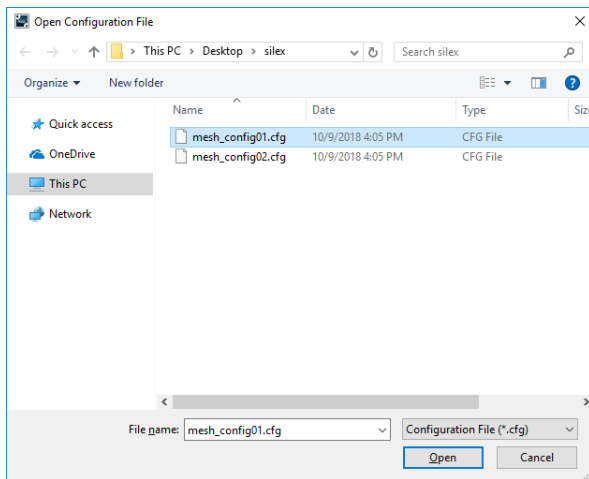

7. The selected configuration file is displayed under **Configuration File Name**. Repeat 5-6 to specify the configuration file for all BR-400AN units.

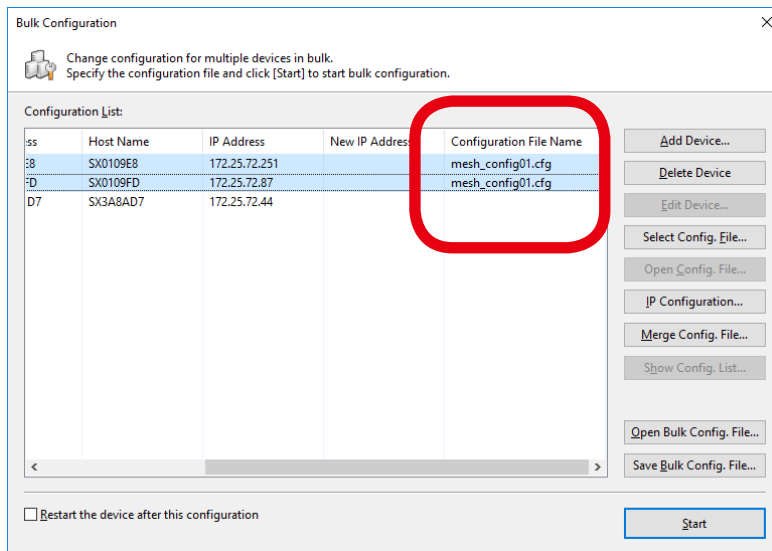

8. When the configuration file is specified for all BR-400AN units (1), click **IP Configuration** (2).

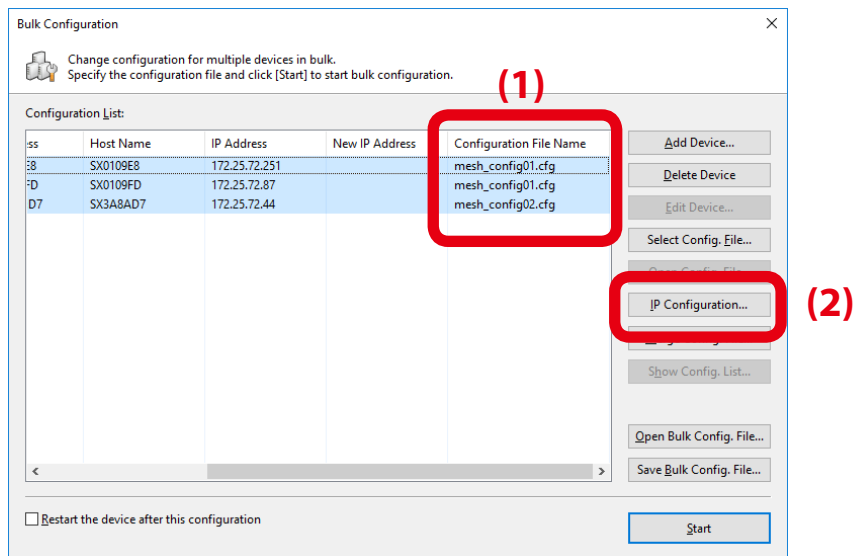

9. Specify the IP address range to configure for BR-400AN units (1).
When the setting is finished, click **OK** (2).

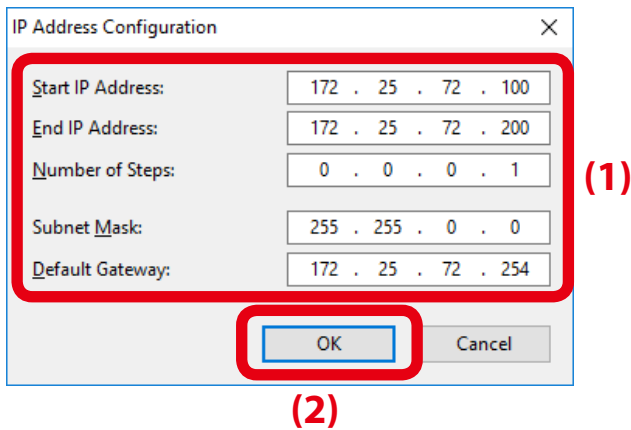

The image shows a dialog box titled "IP Address Configuration" with a close button (X) in the top right corner. The dialog contains five input fields, each with a label and a text box containing IP address values:

- Start IP Address:** 172 . 25 . 72 . 100
- End IP Address:** 172 . 25 . 72 . 200
- Number of Steps:** 0 . 0 . 0 . 1
- Subnet Mask:** 255 . 255 . 0 . 0
- Default Gateway:** 172 . 25 . 72 . 254

At the bottom of the dialog are two buttons: "OK" and "Cancel". A red rectangular box highlights the entire input area, and a red circle highlights the "OK" button. A red "(1)" is placed to the right of the input area, and a red "(2)" is placed below the "OK" button.

**Note**

- For example, if an IP address is configured to three units with the above setting, the first one will obtain the same address as the **Start IP Address** "172.25.72.100". As the **Number of Steps** is "0.0.0.1", the second one and the subsequent one will obtain "172.25.72.101" and "172.25.72.102" respectively.

10. The IP addresses to configure are pre-assigned and displayed under **New IP Address**.

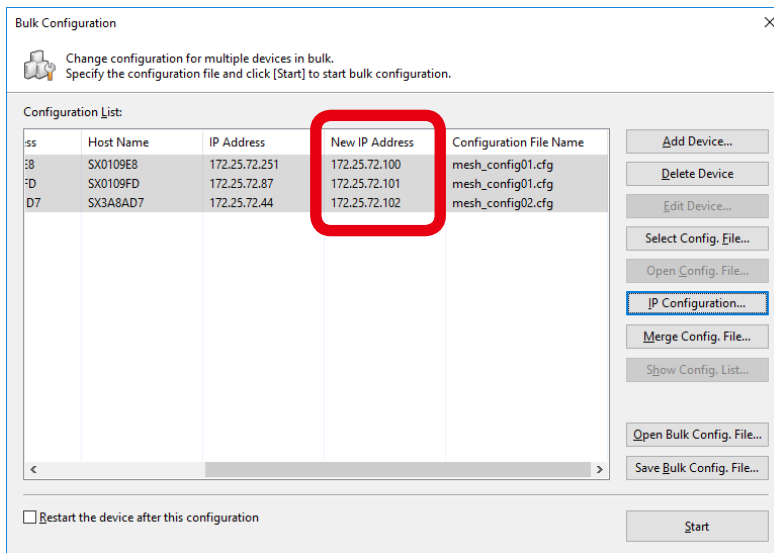

The image shows a dialog box titled "Bulk Configuration" with a close button (X) in the top right corner. The dialog contains a table with the following columns: "ss", "Host Name", "IP Address", "New IP Address", and "Configuration File Name". The table has three rows of data:

ss	Host Name	IP Address	New IP Address	Configuration File Name
:B	SX0109E8	172.25.72.251	172.25.72.100	mesh_config01.cfg
:D	SX0109FD	172.25.72.87	172.25.72.101	mesh_config01.cfg
D7	SX3A8AD7	172.25.72.44	172.25.72.102	mesh_config02.cfg

A red rectangular box highlights the "New IP Address" column. To the right of the table is a vertical list of buttons: "Add Device...", "Delete Device", "Edit Device...", "Select Config. File...", "Open Config. File...", "IP Configuration..." (highlighted with a blue border), "Merge Config. File...", "Show Config. List...", "Open Bulk Config. File...", and "Save Bulk Config. File...". At the bottom left, there is a checkbox labeled "Restart the device after this configuration". At the bottom right, there is a "Start" button.

11. Check the check boxes of BR-400AN units to configure (1) and click **Start** (2).

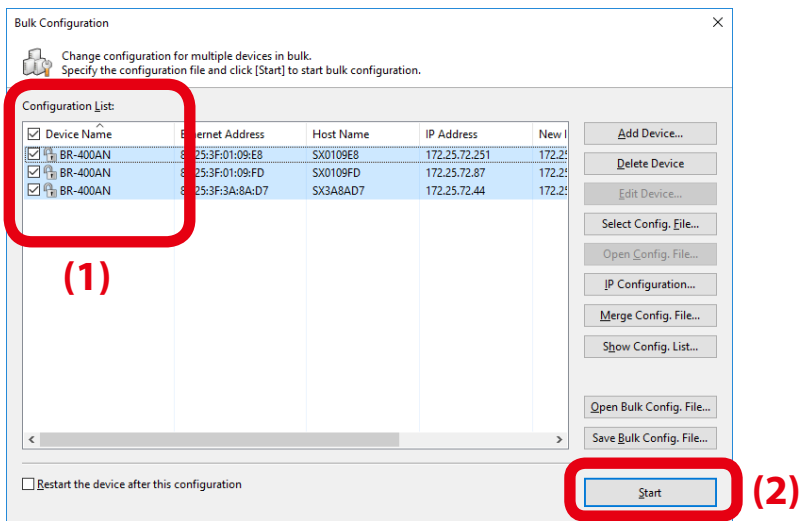

TIP

- Please do not check the check box at **Restart the device after this configuration**. The configuration may fail as it makes all BR-400AN units restart regardless of the Mesh network status when the configuration is completed.



Note

- For changes to take effect, BR-400AN needs to be restarted.
- If the check box at the left of **Device Name** is checked, all check boxes are checked.

12. The progress bar is displayed during the configuration and the result is displayed when the configuration is completed. Click **Close** when the configuration is completed.

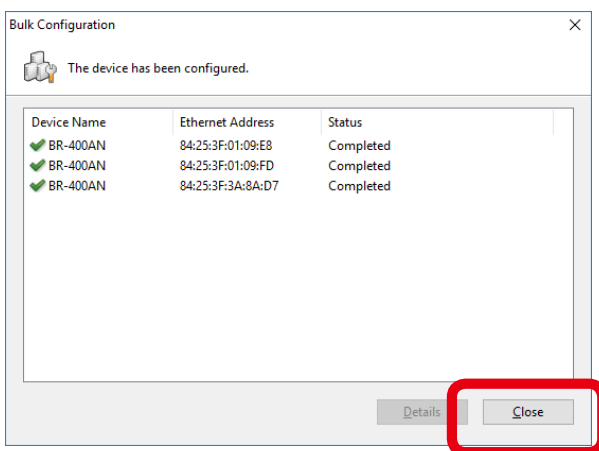

TIP

- If the result status does not say "Completed", modify the setting of the configuration file and try again.

Select **File - Exit** from the menu to finish AMC Manager®.

Turn off the BR-400AN units. When the BR-400AN units are turned on again at the place where you actually use them, they will start with the new settings.

Product Installation

1. After the bulk configuration is completed, bring one of BR-400AN units to a location of installation. Start the BR-400AN before you fix it to that location.
2. Check the STATUS LED of the BR-400AN.
When it configures the Mesh network, the STATUS LED turns as follows according to a link quality.

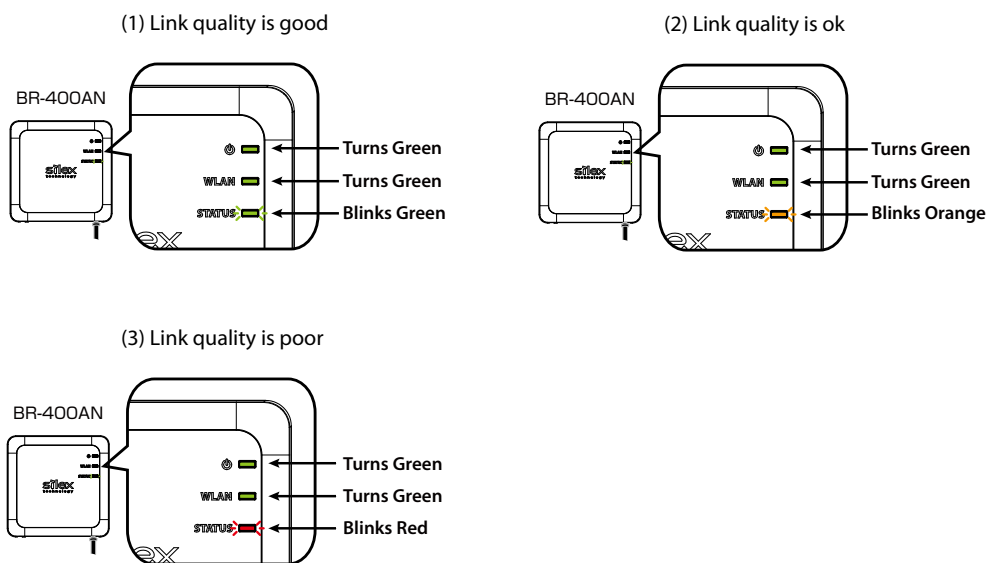

TIP

- When **Route Refresh Function** is set to **DISABLE**, the link quality is not refreshed unless the number of BR-400AN units increases or decreases in the Mesh network. It is recommended to set **ENABLE** for **Route Refresh Function** until you finish installation.
- When the STATUS LED turns red, adjust the location of the BR-400AN. Refer to **3** for details.



Note

- The link quality is the average value of communication quality for each route. To check the communication quality value of BR-400AN, Mesh Monitor is required.
- When the communication quality is good, it has a higher transmission rate and stable communication.
- The refresh interval for the link quality changes according to the value of **Route Refresh Interval**.
If the value of **Route Refresh Interval** is set smaller, the refresh interval of the link quality becomes shorter.
- The STATUS LED blinks when the packets are sent or received.
- When the BR-400AN is operating in MAP mode, the WLAN LED turns orange.

3. To improve a link quality, confirm the followings and change the location of installation if necessary.

- No reinforcing bars, metal and concrete walls or poles are installed in front of the radio emission portion.
- Not too far away from the other BR-400AN units
- The bottom surface of BR-400AN is not facing a concrete wall.

4. Repeat **1-3** and adjust the unit location one by one. When the adjustment is finished for all units, fix them to the location.

The product installation is now completed.

4-3. Configuration Change Using Mesh Monitor

Some of the BR-400AN's setting can be changed using Mesh Monitor.

The setting can be changed also by using AMC Manager but if Mesh Monitor is used, you can check the simulated Mesh route to change the setting.



Note

- For details on Mesh Monitor, refer to the Mesh Monitor User's Manual.
- The following settings can be configured using Mesh Monitor. For details on each setting, refer to 5-1.

Configuration Items on BR-400AN's Web Page.

- Host name
- Route refresh function
- Route refresh method
- Route refresh interval
- Access Point function
- Network loop avoidance

1. Select a single BR-400AN unit on Mesh Monitor (1) and click the icon **Device configuration** from the toolbar (2).

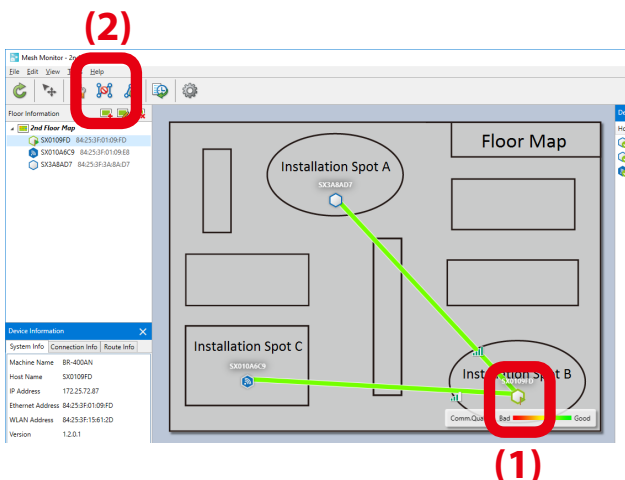

Note

- The setting can also be changed by following methods.
 - Select BR-400AN and click **Tools - Device Configuration**.
 - Right-click on BR-400AN and select **Device Configuration** from the context menu.
- When the password is set to BR-400AN, the password authentication dialog is displayed. Enter the password of BR-400AN (1) and click **OK** (2).

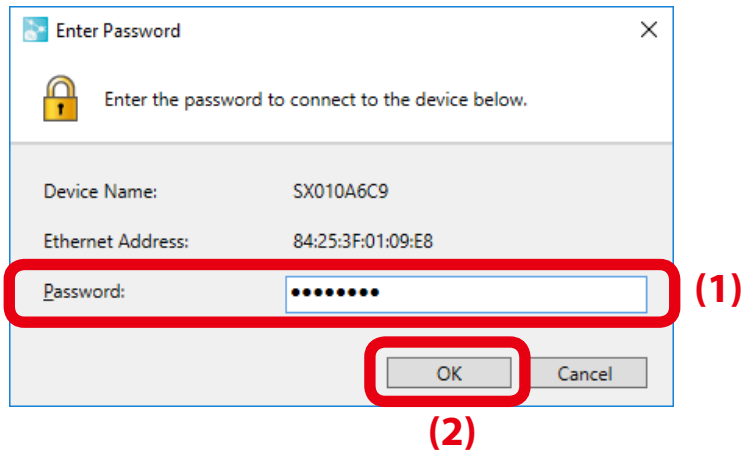

2. In the device configuration window, change the setting and click **OK**.

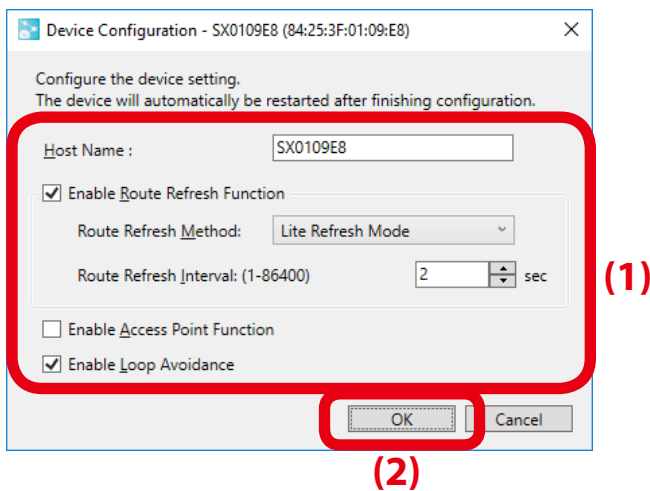

TIP

- When the Access Point feature is enabled, SSID, authentication method and encryption mode also need to be configured. For details on the configuration, refer to **5-1. Configuration Items on BR-400AN's Web Page - Access Point Function Configuration Page**.

3. The result of configuration change is displayed
Click **OK** to close the window.

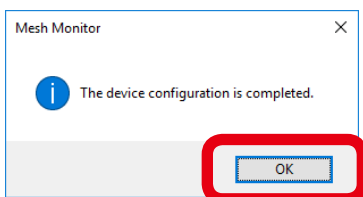

5. List of Configuration Items

This chapter explains the BR-400AN's configuration items.

5-1. Configuration Items on BR-400AN's Web Page

In the Web page, following settings can be configured.

Basic Configuration

- Host name
- IP address
- Wireless setting (frequency band, etc.)
- Mesh network setting

Access Point Function

- Access Point function (ENABLE/DISABLE), operating setting (SSID, authentication method, etc)
- MAC address filter

Option Configuration

- TX power
- Wired LAN speed
- Time to switch into the configuration mode
- NTP function

Login Password

- Password

Hereinafter, the configuration items available on each page and the examples of configuration are described.

Basic Configuration

The basic settings (necessary settings to use BR-400AN mainly in MP mode) can be configured.

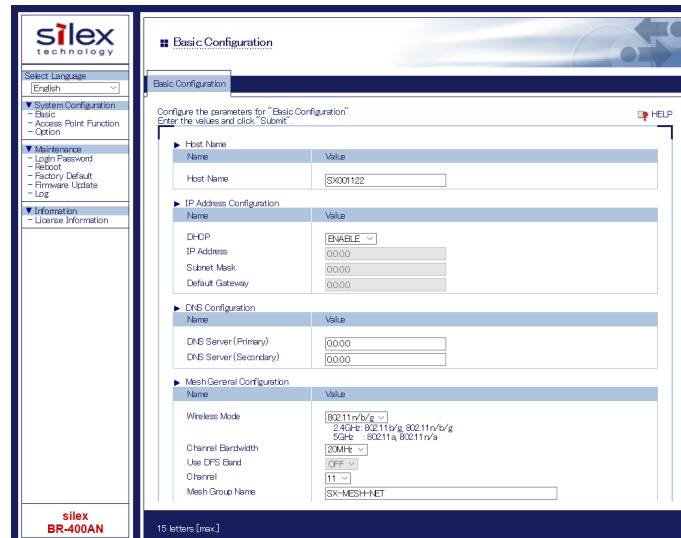

Basic Configuration - Host Name

Host Name

Details	Set the host name. Be sure to use a unique name that is not used by other devices.
Range	Up to 15 characters
Default Value	SXxxxxxx (xxxxxx is a last 6-digit of the Ethernet Address)
Note	This host name is displayed on AMC Manager® and Mesh Monitor.

Basic Configuration - IP Address

DHCP

Details	Enable/Disable the DHCP protocol. To assign an IP address using DHCP, the DHCP server must be running in the same network.
Range	ENABLE/DISABLE
Default Value	ENABLE

IP Address

Details	Configure the IP address.
Range	0.0.0.0 - 255.255.255.255
Default Value	0.0.0.0
Note	When DHCP is enabled, the IP address obtained from DHCP server will be applied.

Basic Configuration - IP Address

Subnet Mask

Details	Configure the subnet mask.
Range	0.0.0.0 - 255.255.255.255
Default Value	0.0.0.0
Note	When DHCP is enabled, the subnet mask obtained from DHCP server will be applied. When 0.0.0.0 is set, the subnet mask appropriate for the IP address class will automatically be assigned.

Default Gateway

Details	Set the gateway address. If "0.0.0.0" is set, this setting is disabled.
Range	0.0.0.0 - 255.255.255.255
Default Value	0.0.0.0
Note	When DHCP is enabled, the default gateway obtained from DHCP server will be applied.

Basic Configuration - DNS Configuration

DNS Server (Primary)

Details	Set a primary DNS server address.
Range	0.0.0.0 - 255.255.255.255
Default Value	0.0.0.0
Note	When DHCP client is enabled, the DNS server address obtained from DHCP server will be applied.

DNS Server (Secondary)

Details	Set a secondary DNS server address.
Range	0.0.0.0 - 255.255.255.255
Default Value	0.0.0.0
Note	When DHCP client is enabled, the DNS server address obtained from DHCP server will be applied.

Basic Configuration - Mesh General Configuration	
Wireless Mode	
Details	Select the IEEE 802.11 wireless mode.
Range	802.11b/g, 802.11n/b/g, 802.11a, 802.11n/a
Default Value	802.11n/b/g
Note	802.11b/g : Uses IEEE802.11b or IEEE802.11g. 802.11a : Uses IEEE802.11a. 802.11n/b/g : Uses IEEE 802.11n, IEEE 802.11b or IEEE 802.11g. 802.11n/a : Uses IEEE802.11n or IEEE802.11a.
Channel Bandwidth	
Details	Set the frequency bandwidth. This setting is necessary when using 802.11n/b/g or 802.11n/a.
Range	20MHz/40MHz
Default Value	20MHz
Note	40MHz (High speed) : Uses double bandwidth. Two neighboring bandwidths are combined together for high speed transmission. 20MHz (Standard) : Uses standard (single) bandwidth. If your network becomes unstable when using 40MHz, change it to 20MHz (Standard). * Do not try to use 20MHz and 40MHz together in the same Mesh network.
Use DFS Band	
Details	Select whether to use the DFS band channel as a channel (ON/OFF).
Range	ON / OFF
Default Value	OFF
Note	If this setting is enabled, the channels of DFS band can be selected for the channel setting.

Basic Configuration - Mesh General Configuration	
Channel	
Details	Set the wireless channel. A channel is the divided frequency bandwidth. In a wireless network, bandwidth is divided up so that more devices can communicate at a time. The selectable channels will differ depending on the wireless mode.
Range	When the wireless mode is 802.11b/g or 802.11n/b/g : (US) 1-11 (EU) 1-13 When the wireless mode is 802.11a or 802.11n/a : (US) 36/40/44/48/149/153/157/161/165 (EU) 36/40/44/48
Default Value	11
Note	If your network becomes unstable due to interference with other wireless devices, it could be improved by changing the channel. The channel you can use will differ depending on the country. When Use DFS Band is ON , the following channels can be used, however, if the following channels are used and radar signals are detected when BR-400AN is turned on, communication will be lost for a certain amount of time (*1). (US/Canada) 52/56/60/64/100/104/108/112/116(*2)/132/136/140 (EU) 52/56/60/64/100/104/108/112/116/120/124/128/132/136/140 The extended channel setting will depend on the communication channel. *1 This period of time will differ on each country. *2 When Channel Bandwidth is 40MHz , 116ch cannot be used.
Extension Channel	
Details	Set the extended channel when 40MHz is selected for channel bandwidth. Available extended channels will differ depending on the channel.
Range	When the wireless mode is 802.11b/g or 802.11n/b/g: (US) 1-11 (EU) 1-13 When the wireless mode is 802.11a or 802.11n/a: (US) 36/40/44/48/149/153/157/161 (EU) 36/40/44/48
Default Value	7
Note	When Use DFS Band is ON , the following channels can be used. (US/Canada) 52/56/60/64/100/104/108/112/132/136 (EU) 52/56/60/64/100/104/108/112/116/120/124/128/132/136
DFS Primary Channel	
Details	Set the alternative channel to use when radar signals are detected during DFS channels are used. If the alternative channel is not specified or radar signal is detected even for that channel, the channel is randomly switched. For details on DFS channel switch, refer to 2-7. Wireless Interference Information - DFS .
Range	(US/Canada) NONE/52/56/60/64/100/104/108/112/116/132/136/140 (EU) NONE/52/56/60/64/100/104/108/112/116/120/124/128/132/136/140
Default Value	NONE
Note	When radar signals are detected on all channels, BR-400AN will switch the channel again in approximately 30 mins, starting from the pre-configured channel.

Basic Configuration - Mesh General Configuration

Mesh Group Name

Details	Set a group name of the Mesh network to create or join (up to 32 characters). The Mesh network is identified by the Mesh group name. To join the Mesh network, BR-400AN needs to have the same Mesh group name as that Mesh network.
Range	A string of 1-32 alphanumeric characters
Default Value	SX-MESH-NET

Mesh Encryption Key

Details	Set the encryption key that BR-400AN uses for the Mesh network communication.
Range	A string of 1-32 alphanumeric characters
Default Value	silex technology, Inc.
Note	The Mesh encryption key must be the same for all Mesh devices to join the Mesh network.

Basic Configuration - Mesh Route Configuration

Max Hop Count

Details	Set the maximum number of the Mesh devices that BR-400AN can create the Mesh route for. The recommended number of hop is 5. When 6 or more hops are needed, select No Limit . As the number of hops increases, the communication speed decreases.
Range	1, 2, 3, 4, 5, No Limit
Default Value	5
Note	The number of hops represents the number of BR-400AN units to use for a communication relay. This number should exclude the number of source unit (1 hop = 2 devices, 5 hops = 6 devices).

Route Refresh Function

Details	Enable/Disable the regular optimization for the Mesh route.
Range	ENABLE / DISABLE
Default Value	ENABLE

Route Refresh Method

Details	Set a refresh method for the Mesh route by selecting from the following options. Light Refresh Mode : Reconstructs the route only in receiving direction to BR-400AN. Full Refresh Mode : Reconstructs the route in both receiving direction to BR-400AN and transmission direction from BR-400AN.
Range	Light Refresh Mode / Full Refresh Mode
Default Value	Light Refresh Mode

Basic Configuration - Mesh Route Configuration

Route Refresh Interval

Details	Set a refresh interval for the Mesh route (sec).
Range	1-86400
Default Value	2

Basic Configuration - Mesh Route Configuration

Network Loop Avoidance

Details	Enable/Disable the network loop avoidance. If this setting is enabled, BR-400AN handles a communication regularly to avoid a network loop.
Range	ENABLE /DISABLE
Default Value	ENABLE
Note	If two or more BR-400AN units are connected to the existing network via wired LAN, this setting needs to be enabled on all of them.

Sample Setting for Host Name



For the host name, enter a string with 15 or less characters.

Name	Value
Host Name	SX0109E8

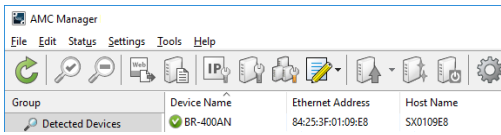
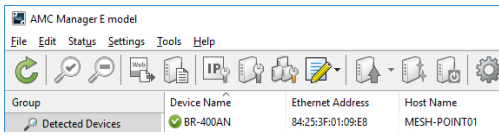

Name	Value
Host Name	MESH-POINT01

If the host name is changed, you can easily identify that unit on AMC Manager® and Mesh Monitor.

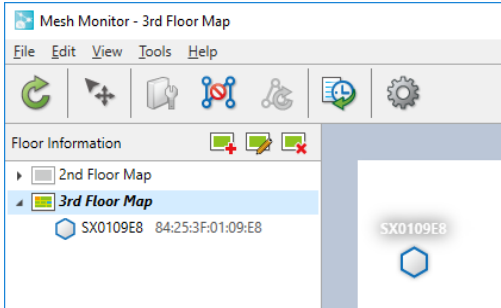
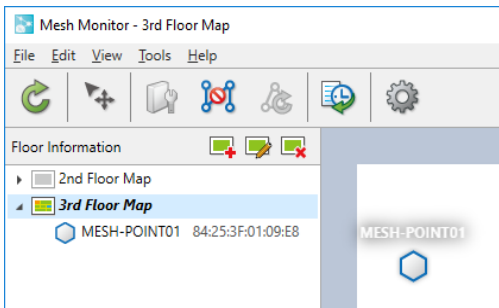
Sample Setting for Mesh General Configuration

Configure the setting as follows when you want to use IEEE802.11n/a for **Wireless Mode** and 40ch for **Channel Bandwidth** to configure the Mesh network.

Name	Value
Wireless Mode	802.11 n/a 2.4GHz: 802.11 b/g, 802.11 n/b/g 5GHz : 802.11 a, 802.11 n/a
Channel Bandwidth	40MHz
Use DFS Band	OFF
Channel	4C Extension Channel 36
Mesh Group Name	SX-MESH-NET-11a
Mesh Encryption Key	●●●●●●●●●●●●●●●●●●●●●●●●●●●●●●●●

Sample Setting for DFS Channel Use

To use the DFS band channels, select **ON** for **Use DFS Band**.

Name	Value
Wireless Mode	802.11 n/a 2.4GHz: 802.11 b/g, 802.11 n/b/g 5GHz : 802.11 a, 802.11 n/a
Channel Bandwidth	40MHz
Use DFS Band	ON
Channel	100 Extension Channel 104 DFS Primary Channel 108
Mesh Group Name	SX-MESH-NET-11a
Mesh Encryption Key	●●●●●●●●●●●●●●●●●●●●●●●●●●●●●●●●

Sample Setting for Mesh Route Configuration

By configuring the Mesh route setting, you can set the action of BR-400AN to take when the Mesh route is updated. For example, when you want to set '5' for **Max Hop Count** and reconstruct the Mesh route in both receiving and transmitting direction in every 5 mins, configure the setting as below.

Name	Value
Max Hop Count	5
Route Refresh Function	ENABLE
Route Refresh Method	Full refresh Mode
Route Refresh Interval	300
Network Loop Avoidance	ENABLE

Access Point Function Configuration Page

The Access Point function can be enabled/disabled and the detailed setting can be configured.

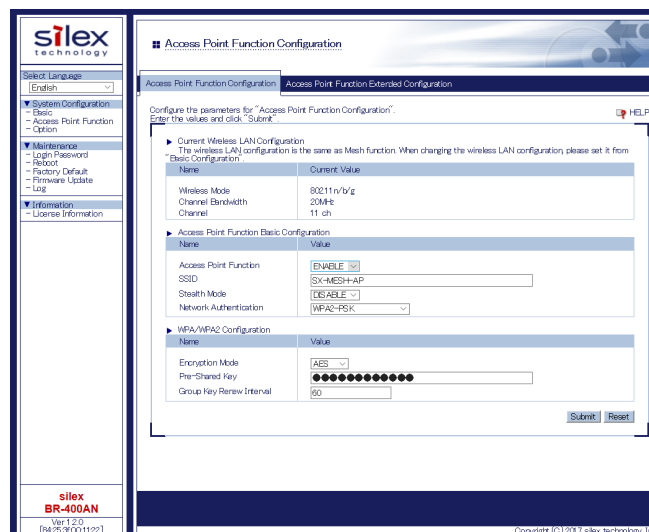

Access Point Function Configuration - Access Point Function Basic Configuration

Access Point Function

Details	Enable/Disable the Access Point feature. If this setting is enabled, wireless clients (e.g. PC, tablet devices) are allowed to connect to BR-400AN. Once the wireless clients are connected to BR-400AN, they can join the Mesh network.
Range	ENABLE / DISABLE
Default Value	DISABLE
Note	For the wireless mode and channel to use for Access Point function, the settings of Mesh General Configuration will be applied. When the Access Point feature is enabled, up to 100 wireless client devices can be connected. However, depending on the number of Mesh devices used in the Mesh network, the maximum number of connectable devices could be reduced. The maximum number of connectable devices is 100 when 12 Mesh devices are used, but as the number of Mesh devices increases from 12, the maximum number of connectable devices decreases by two.

SSID

Details	Set an SSID of the wireless LAN for BR-400AN. The SSID is an ID that distinguishes a wireless LAN network from others.
Range	A string of 1-32 alphanumeric characters
Default Value	SX-MESH-AP

Stealth Mode

Details	Enable/Disable the stealth mode function.
Range	ENABLE / DISABLE
Default Value	DISABLE
Note	When the stealth mode of BR-400AN is enabled, BR-400AN will not be found by the wireless client devices even when it is searched over the wireless LAN. To connect to BR-400AN, the SSID, authentication method and encryption mode of BR-400AN need to be entered from the wireless client devices.

Access Point Function Configuration - Access Point Function Basic Configuration

Network Authentication

Details	Select the network authentication mode that will be used to connect to your wireless devices. To ensure a secure network, it is recommended to use WPA/WPA2. When IEEE 802.11n is used, only AES can be used for encryption mode.
Range	Open, Shared, WPA-PSK, WPA2-PSK, WPA/WPA2-PSK, 802.1X, WPA-Enterprise, WPA2-Enterprise, WPA/WPA2-Enterprise
Default Value	WPA2-PSK
Note	<p>Open (Open System): Allows all access without authentication. For encryption mode, WEP can be used.</p> <p>Shared (Pre-Shared Key): Uses WEP key for encryption and allows access only from those with the same WEP key. For encryption mode, WEP can be used.</p> <p>WPA-PSK: Uses PSK for network authentication. For encryption mode, TKIP/AES/AUTO can be selected. The encryption key will be generated by communicating with your wireless devices using a Pre-Shared key. WEP key setting is not used for this mode.</p> <p>WPA2-PSK: Uses PSK for network authentication. For encryption mode, AES/AUTO can be selected. The encryption key will be generated by communicating with your wireless devices using a Pre-Shared key. WEP key setting is not used for this mode.</p> <p>WPA/WPA2-PSK: Uses both WPA-PSK and WPA2-PSK authentication.</p> <p>802.1X: Uses IEEE 802.1X user authentication and WEP encryption.</p> <p>WPA-Enterprise: Uses IEEE 802.1X user authentication and TKIP/AES/AUTO encryption.</p> <p>WPA2-Enterprise: Uses IEEE 802.1X user authentication and AES/AUTO encryption.</p> <p>WPA/WPA2-Enterprise: Uses IEEE 802.1X user authentication and AES/AUTO encryption.</p> <p>When running in IEEE 802.11n, Shared and IEEE 802.1X authentication modes and WEP and TKIP encryption modes cannot be used.</p>

Access Point Function Configuration - WEP Configuration

WEP

Details	Enable/Disable WEP encryption. If WEP encryption is used, wireless communication will be encrypted using the settings of WEP Key 1-4 and Key Index .
Range	OFF / ON
Default Value	OFF
Note	If encryption is not enabled, data is not encrypted and is sent as is. To ensure higher security, enabling encryption is recommended.

Key Index

Details	Select the number of the WEP key to use for encryption (1-4). This setting must be the same as that of your wireless devices.
Range	1 - 4
Default Value	1

WEP Key1-4

Details	Set the WEP key for WEP encryption. Up to 4 WEP keys can be set. This setting must be the same as that of your wireless devices. A WEP key must be entered using hexadecimal or alphanumeric characters.
Range	5 or 13 characters 10 or 26 digit value
Default Value	(None)
Note	In most cases, alphanumeric characters are used. Enter 5 characters if the key size is 64bit or 13 characters if the key size is 128bit. For Hexadecimal, a value consists of numbers (0-9) and English letters (A-F). Enter a 10-digit value if the key size is 64bit or a 26-digit value if the key size is 128bit.

Access Point Function Configuration - WPA/WPA2 Configuration

Encryption Mode

Details	Select the encryption mode to use for WPA-PSK, WPA2-PSK, WPA/WPA2-PSK, WPA-Enterprise, WPA2-Enterprise, WPA/WPA2-Enterprise authentication.
Range	TKIP/AES/AUTO
Default Value	AES
Note	When the network authentication mode is WPA2-PSK, WPA/WPA2-PSK, WPA2-Enterprise, WPA/WPA2-Enterprise, TKIP cannot be used.

Access Point Function Configuration - WPA/WPA2 Configuration	
Pre-Shared Key	
Details	Set the Pre-Shared Key to use for TKIP/AES encryption. The Pre-Shared Key is a keyword used to create the encryption key. It is also referred to as ' network key' or ' password '.
Range	8-63 alphanumeric characters 64 hexadecimal value
Default Value	PreSharedKey
Note	In most case, alphanumeric characters are used (8-63 characters). For Hexadecimal, enter 64-character string that consists of numbers (0-9) and English letters (A-F). This value must be the same as that of the wireless device you want to connect.
Group key renew interval	
Details	Set the refresh interval for Pre-Shared Key (min). If 0 is set, this setting is disabled.
Range	0 - 1440
Default Value	60

Access Point Function Configuration - RADIUS Server Configuration	
Server IP	
Details	Set the IP Address of RADIUS server. This needs to be set only when the network authentication is 802.1X, WPA-Enterprise, WPA2-Enterprise or WPA/WPA2-Enterprise.
Range	0.0.0.0 - 255.255.255.255
Default Value	0.0.0.0
Port Number	
Details	Set the port number used to communicate with RADIUS server.
Range	0 - 65535
Default Value	1812
Shared Secret	
Details	Set the secret key used to communicate with RADIUS server.
Range	Up to 32 characters
Default Value	(None)

Sample Setting for Access Point Function

When the Access Point function is enabled, some configuration items (SSID, authentication method, encryption mode, etc.) will become available.

E.g.) To set WEP encryption for Access Point

Access Point Function Basic Configuration	
Name	Value
Access Point Function	ENABLE ▾
SSID	SX-MESH-AP
Stealth Mode	DISABLE ▾
Network Authentication	Open ▾

WEP Configuration	
Name	Value
WEP	ON ▾
Key Index	1 ▾
WEP Key1	●●●●●●
WEP Key2	
WEP Key3	
WEP Key4	

E.g.) To set WPA2-PSK (authentication method) and AES (encryption mode) for Access Point

Access Point Function Basic Configuration	
Name	Value
Access Point Function	ENABLE ▾
SSID	SX-MESH-AP
Stealth Mode	DISABLE ▾
Network Authentication	WPA2-PSK ▾

WPA/WPA2 Configuration	
Name	Value
Encryption Mode	AES ▾
Pre-Shared Key	●●●●●●●●●●●●●●
Group Key Renew Interval	60

E.g.) To establish the IEEE802.1X environment with RADIUS server and wireless client devices

▶ Access Point Function Basic Configuration

Name	Value
Access Point Function	ENABLE ▾
SSID	MESH-AP001
Stealth Mode	DISABLE ▾
Network Authentication	WPA/WPA2-Enterprise ▾

▶ WPA/WPA2 Configuration

Name	Value
Encryption Mode	AES ▾
Group Key Renew Interval	60

▶ RADIUS Server Configuration

Name	Value
Server IP	192.168.0.220
Port Number	1812
Shared Secret	●●●●●●●●

Access Point Function Extended Configuration Page

The filter setting can be configured to allow or deny communication with a specific wireless client device.

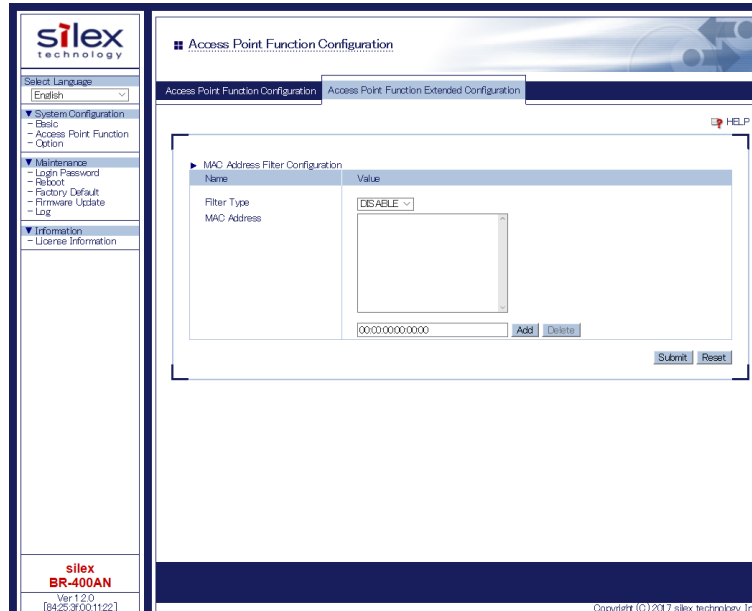

Access Point Function Extended Configuration - MAC Address Filter Configuration

Filter Type

Details	Set a security type for MAC address filter to use over a wireless LAN.
Range	DISABLE/DENY/ALLOW
Default Value	DISABLE

MAC Address

Details	Register the MAC address of the target wireless client device to enable a filter for. By registering the MAC address, access from a wireless LAN can be filtered.
Range	00:00:00:00:00:01 - FF:FF:FF:FF:FF:FE
Default Value	00:00:00:00:00:00
Note	If a filter type is DISABLE , access from all devices is allowed. If a filter type is DENY , access from the devices registered to MAC Address filter list is denied. If a filter is ALLOW , only access from the devices registered to MAC Address filter list is allowed. Up to 1024 MAC Addresses can be registered.

Sample Setting for MAC Address Filter

E.g.) To deny access from the specified wireless client device

Name	Value
Filter Type	DENY
MAC Address	84:25:3F:11 22:33

E.g.) To allow access from the specified wireless client device only

Name	Value
Filter Type	ALLOW
MAC Address	84:25:3F:11 22:33

Option Configuration Page

Transmission power, wired LAN, NTP function settings can be configured.

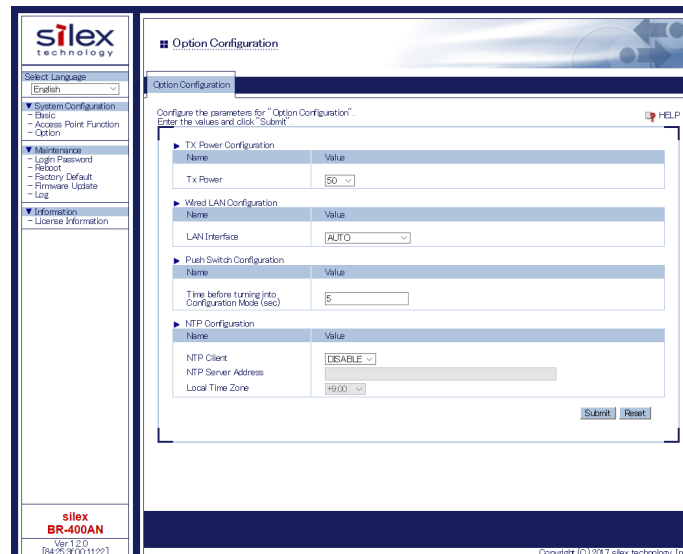

Option Configuration - TX Power Configuration

TX Power (%)

Details	<p>Set the transmission power for wireless LAN.</p> <p>If a smaller value is set, a wireless distance from BR-400AN is shortened and the scope of search can be narrowed down. By narrowing down the scope of search, interference to other network can be reduced.</p> <p>If a larger value is set, a wireless distance from BR-400AN is expanded and the scope of search can be broadened. By broadening the scope of search, remote devices can be discovered.</p>
Range	10, 20, 30, 40, 50, 60, 70, 80, 90, 100
Default Value	50

Option Configuration - Wired LAN Configuration

Wired LAN Interface

Details	Configure the physical network type.
Range	AUTO/10Base-T-Half/10Base-T-Full/100Base-TX-Half/100Base-TX-Full/1000Base-T-Full
Default Value	AUTO
Note	Usually, " AUTO " is used. When BR-400AN is powered on and the LINK LED does not turn on the device that is connected to BR-400AN, change the network type to that of the device.

Option Configuration - Push Switch Configuration	
Time before turning into Configuration Mode (sec)	
Details	Specify the period of time until the BR-400AN turns into the Configuration Mode. If the Push Switch is pressed for the period of time specified here, the BR-400AN will turn into the Configuration Mode.
Range	5-60 (sec)
Default Value	5

Option Configuration - NTP Configuration	
NTP	
Details	Enable/Disable the NTP protocol.
Range	ENABLE/DISABLE
Default Value	DISABLE
NTP Server	
Details	Set the domain name or IP address of the NTP server.
Range	In case of the domain name; Alphanumeric character string (0-128 characters) In case of the IP Address; 0.0.0.0 - 255.255.255.255
Default Value	(None)
Local Time Zone	
Details	Set the local time zone.
Range	-12:00 - +12:00
Default Value	+9:00

Sample Setting of Transmission Power

By configuring the TX power, the wireless distance of BR-400AN can be changed. The default value is set to 50(%). When the default value is used, the wireless distance will be about 20m. When the value is changed to 100(%), the wireless distance will be about 35m.

Name	Value
Tx Power	100 

Login Password Configuration Page

The password to login to the Web page can be configured.

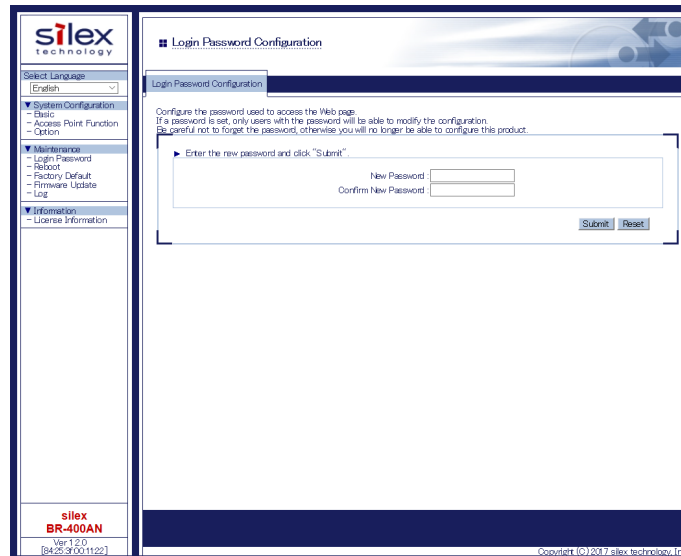

Login Password Configuration	
New Password	
Details	Set the login password (up to 16 ASCII characters). This password is used for authentication when changing settings from the Web configuration page. The new password needs to be entered again to Confirm New Password .
Range	Alphanumeric character string (1-15 characters)
Default Value	(None)
Note	This password is also used to change configuration using AMC Manager® and Mesh Monitor.

6. How to Connect Wireless Client Devices

This chapter explains how to connect wireless client devices (PC, tablet, etc.) to BR-400AN.

**Note**

- When the Access Point feature is enabled, up to 100 wireless client devices can be connected. However, depending on the number of Mesh devices used in the Mesh network, the maximum number of connectable devices could be reduced. The maximum number of connectable devices is 100 when 12 Mesh devices are used, but as the number of Mesh devices increases from 12, the maximum number of connectable devices decreases by two.

6-1. How to Enable Access Point Feature on BR-400AN

To connect the PCs or tablet devices to BR-400AN, the Access Point feature needs to be enabled on BR-400AN. Execute one of the following methods to enable the Access Point feature.

- 1) Use the Web configuration interface to enable the Access Point feature.
- 2) Use AMC Manager® to enable the Access Point feature.
- 3) Use Mesh Monitor to enable the Access Point feature.

How to enable the Access Point feature using the Web configuration interface

1. Access the Web configuration interface of BR-400AN using your Web browser, enter the password and click **Login**.



Note

- For how to access the Web configuration interface, refer to **4-1.Configuration via BR-400AN's Web Page**.
- When the password is not set to BR-400AN, the login password configuration page is displayed.

2. When the Web configuration interface is displayed, click **Access Point Function**.

3. Select **ENABLE** for **Access Point Function**.

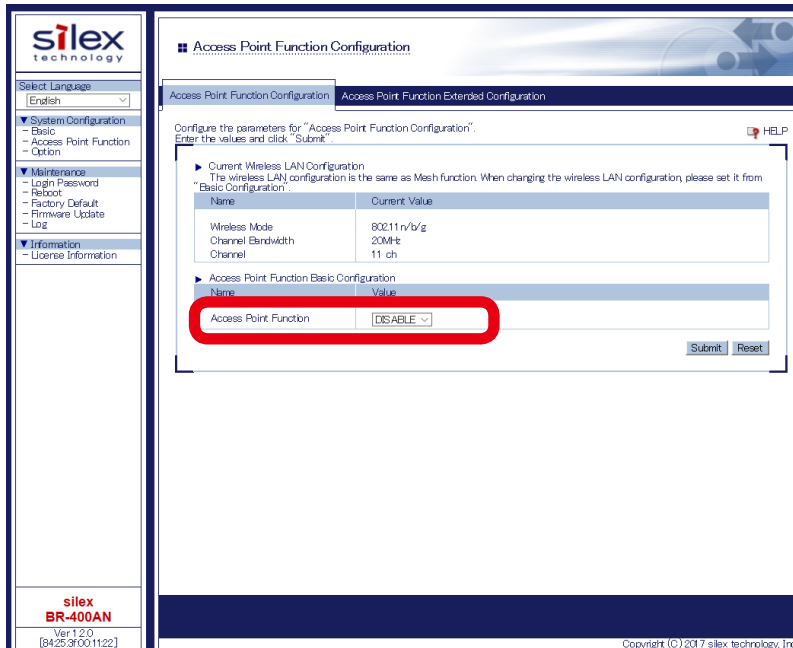

4. The detailed setting of Access Point feature such as SSID, authentication method, etc. can be configured. For details on the configurable items, refer to **5-1. Configuration Items on BR-400AN's Web Page - Access Point Function Configuration Page**. The wireless mode, channel bandwidth and channel cannot be changed in this page. To change these settings, go to the **Basic Configuration** page.

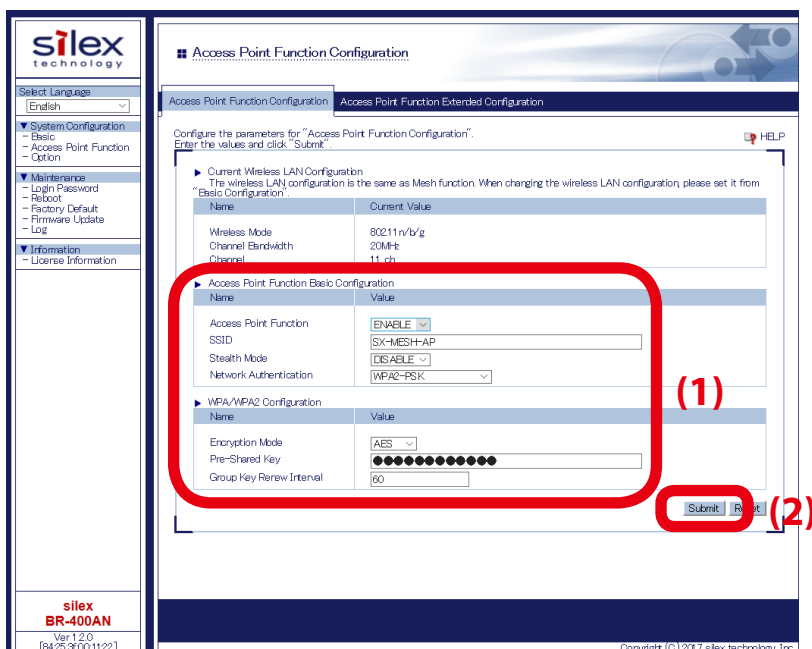

5. When the configuration is completed, restart BR-400AN.

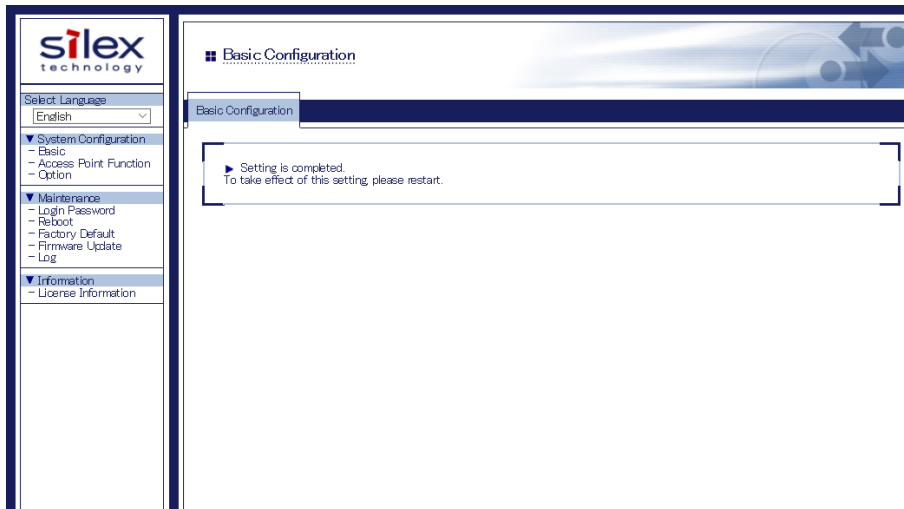

- For details on how to restart BR-400AN, refer to **7-1. Restart**.

Note

How to enable the Access Point feature using AMC Manager®

1. Start AMC Manager®, click the icon **Create the configuration file - Create from Template** from the toolbar.

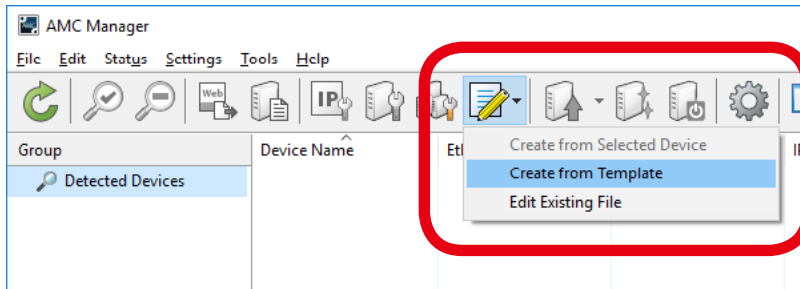

- When the login password is not set to a device, please include that setting to the configuration file. If the login password is not set, the bulk configuration does not perform correctly.



Note

- If you have the configuration file, it is possible to read the setting from that file. In that case, click the icon **Create the configuration file - Edit Existing File**.

2. Select a template file for BR-400AN (1) and click **OK** (2).

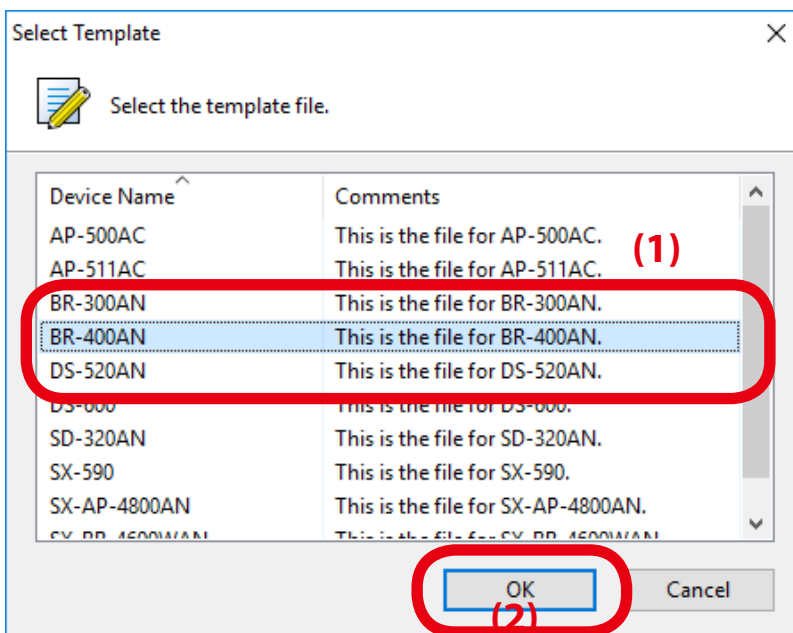

3. Select **Wireless LAN I/F 1** from the configuration category on the left (1).
The corresponding setting items are displayed on the right (2).

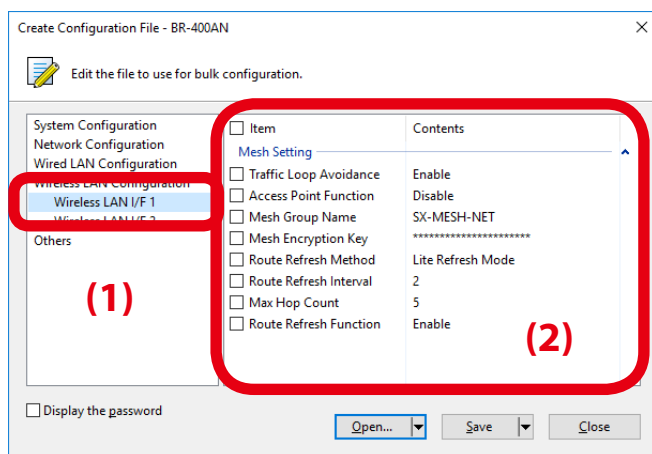

4. Select **Enable** for **Access Point Function** and check the check box.

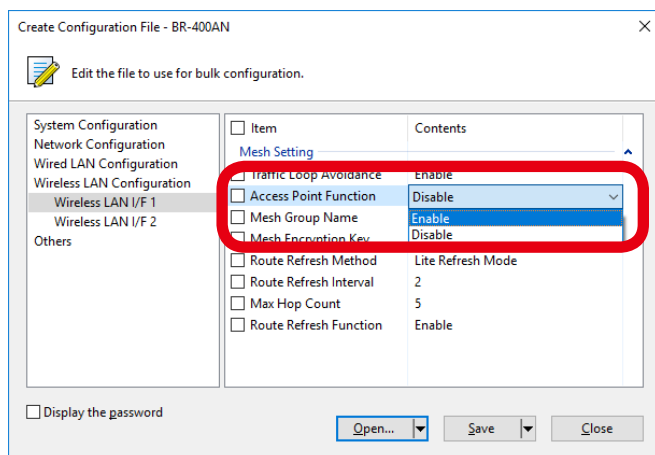

5. Select **Wireless LAN I/F 2** from the configuration category on the left (1), and configure the SSID, authentication and encryption settings on the right (2).

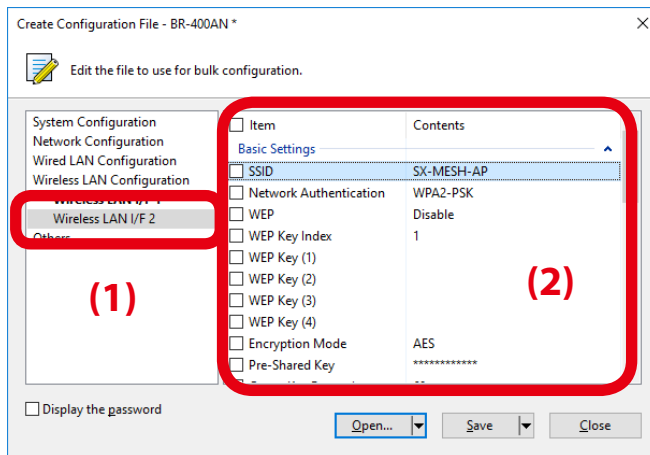

Note

- Only the setting whose check box is checked will be configured to BR-400AN. Remove a check from the setting that you do not want to change.

6. When the configuration is completed, click **Save**.

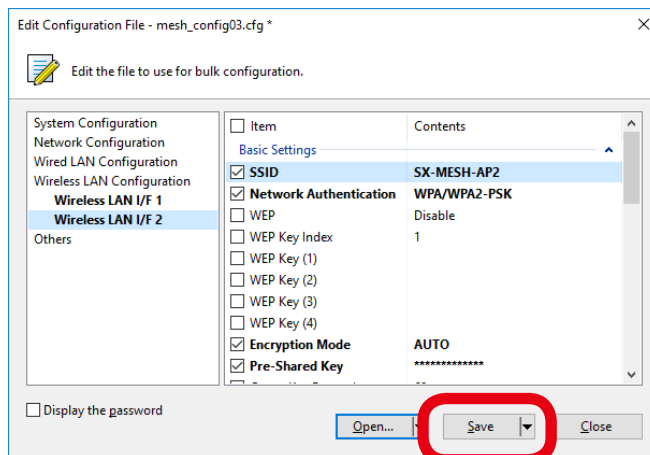

7. Specify the file name and click **Save**.

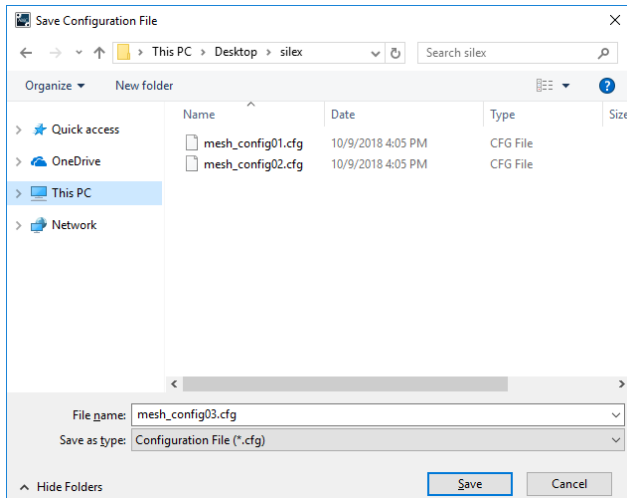

8. Click **Close**.

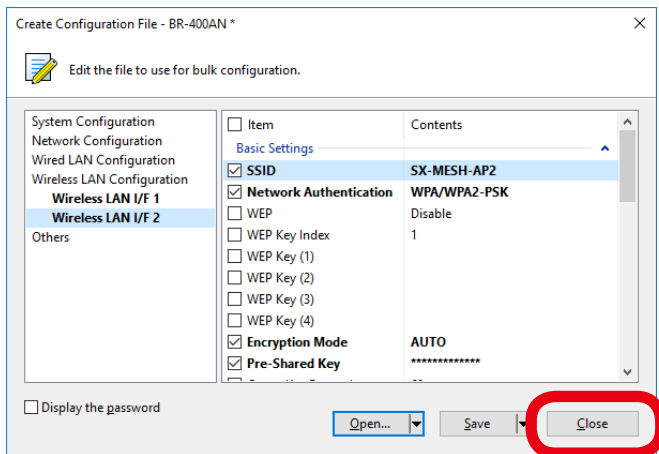

9. Select BR-400AN units to configure in bulk (1) and click the icon **Configure multiple devices in bulk** (2).

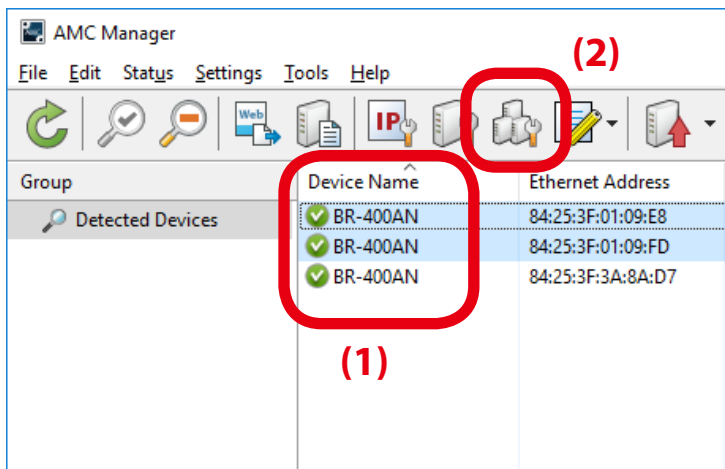

10. Specify the configuration file to use. Select BR-400AN units to configure (1) and click **Select Config. File** (2).

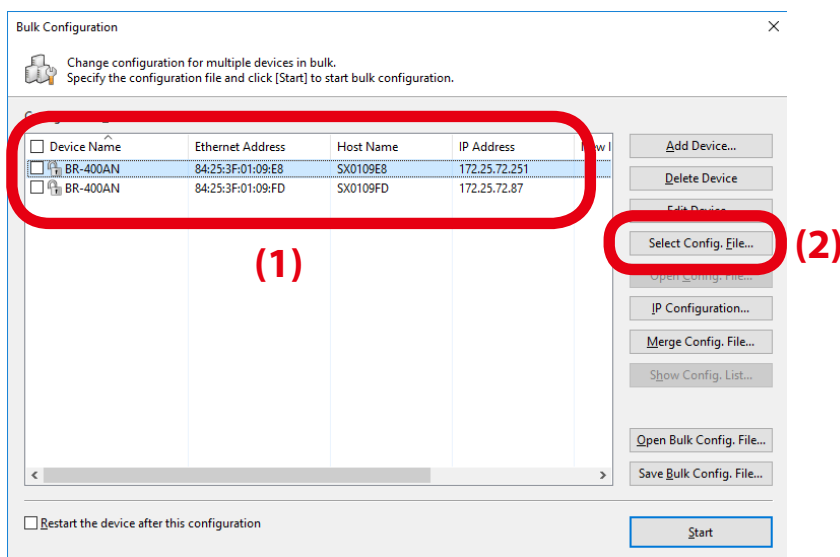

11. Select the configuration file that you have created at 7.

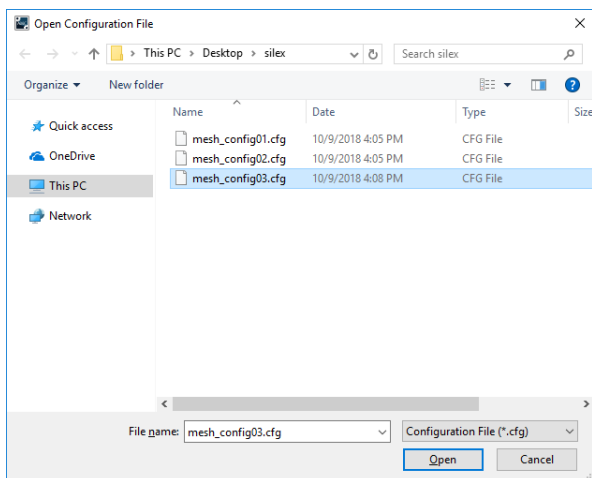

12. The selected configuration file is displayed under **Configuration File Name**.

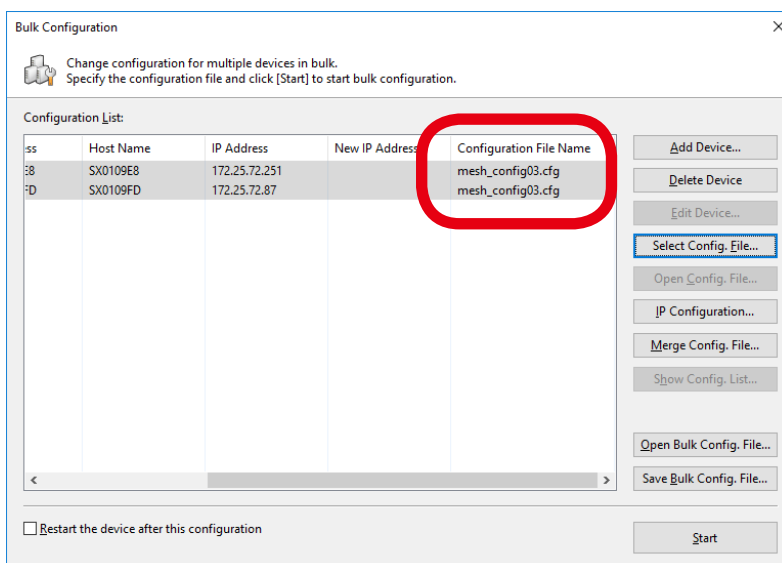

13. Check the check boxes of BR-400AN units to configure in bulk (1) and click **Start** (2).

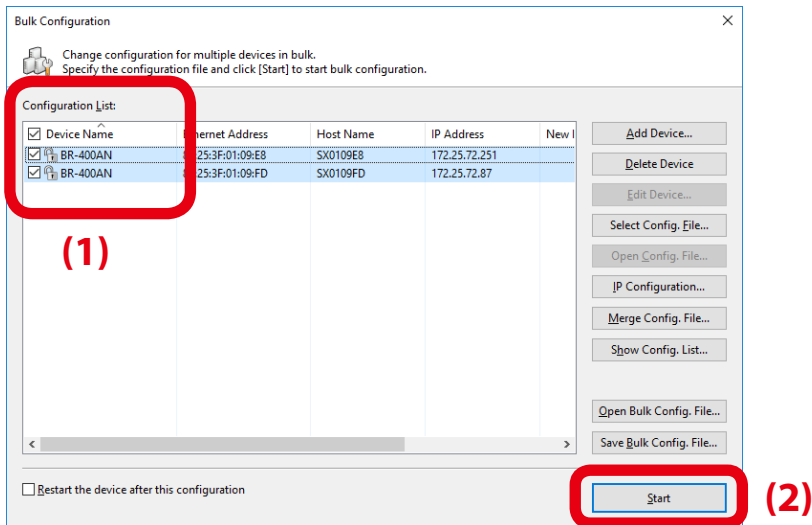

TIP

- Please do not check the check box at **Restart the device after this configuration**. If it is checked, BR-400AN units will automatically be restarted regardless of the Mesh network status and the bulk configuration may not be completed correctly as the result.



Note

- If the check box on the left of **Device Name** is checked, check boxes of all devices will be checked in the list.

14. When the configuration is in progress, the progress bar is displayed and when the configuration is finished, the result is displayed. Click **Close**.

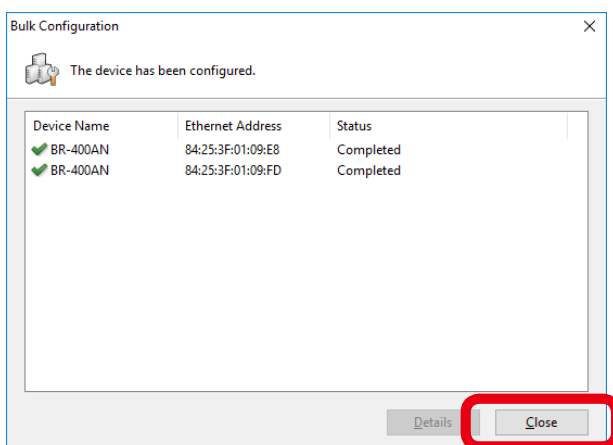

TIP

- If the result status does not say "Completed", modify the setting of the configuration file and try again.

15. Restart all BR-400AN units.

For details on how to restart BR-400AN, refer to **7-1. Restart** in this document or **4-9. Restart** in the AMC Manager® User's Manual.

BR-400AN units will start with a new setting after restart.

The Access Point feature has been enabled.

Click **File - Exit** to finish AMC Manager®.

How to enable the Access Point feature using Mesh Monitor

1. Select a single BR-400AN unit to enable the Access Point feature (1) and click the icon **Device configuration** from the toolbar (2).

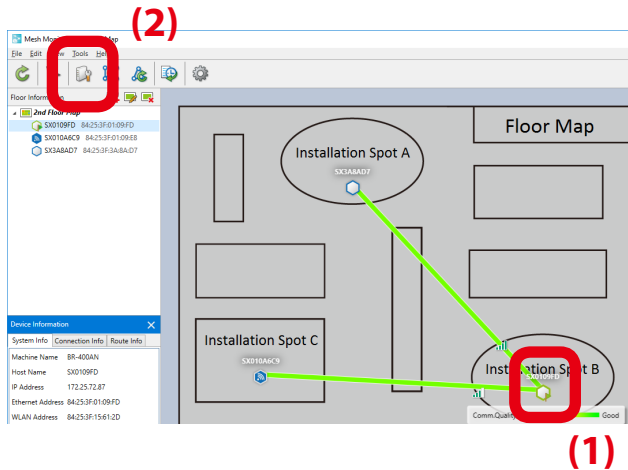

Note

- The device configuration window can also be opened by the following methods:
 - Select BR-400AN and click **Tools - Device Configuration** from the menu bar.
 - Right-click on BR-400AN and select **Device Configuration** from the context menu.
- When the password is set to BR-400AN, the screen below is displayed. Enter the password (1) and click **OK** (2).

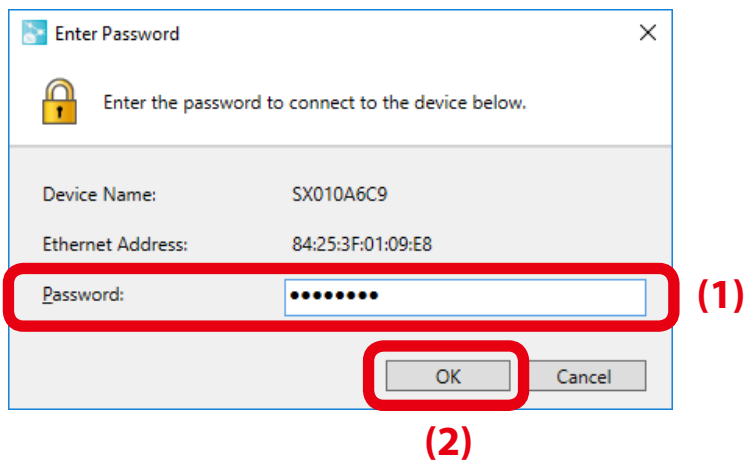

2. Check the check box at **Enable Access Point Function** (1) and click **OK** (2).

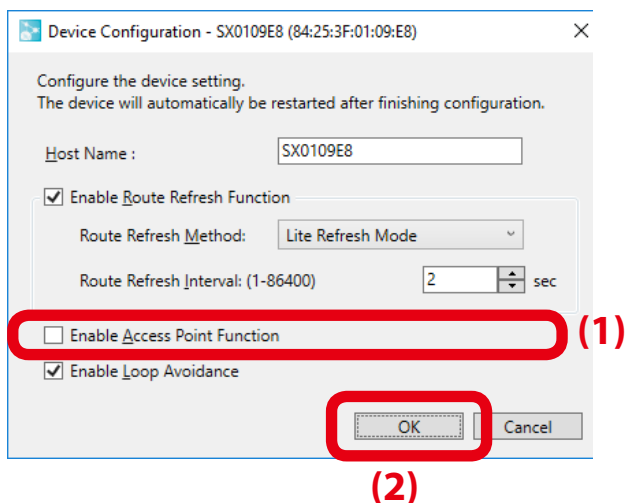

TIP

- When the Access Point feature is enabled, the SSID, authentication method and encryption mode will also need to be configured. For details on the configuration method, refer to **5-1. Configuration Items on BR-400AN's Web Page - Access Point Function Configuration Page**.

3. The result of configuration change is displayed.
Click **OK** to close the device configuration window.

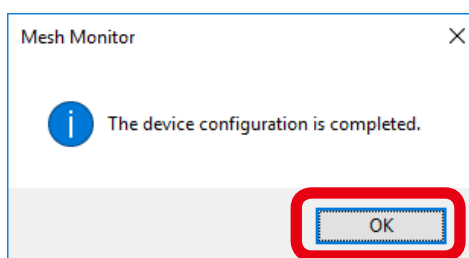

6-2. How to Connect PCs or Tablets to BR-400AN

The following explains how to connect your Windows PC to BR-400AN as a wireless client.

1. Click the below icon from the task tray to open the wireless connection window.

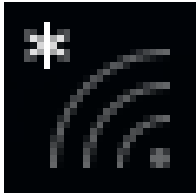

2. Select the SSID of BR-400AN from the list of wireless networks (1) and click **Connect** (2).

(1)

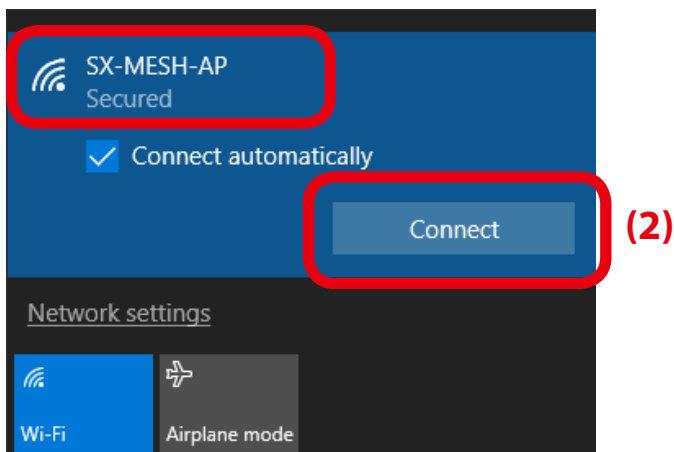

- If the check box at **Connect automatically** is checked, the PC is automatically connected to BR-400AN when it is started.

Note

3. Enter the security key of BR-400AN for **Enter the network security key** (1) and click **Next** (2).

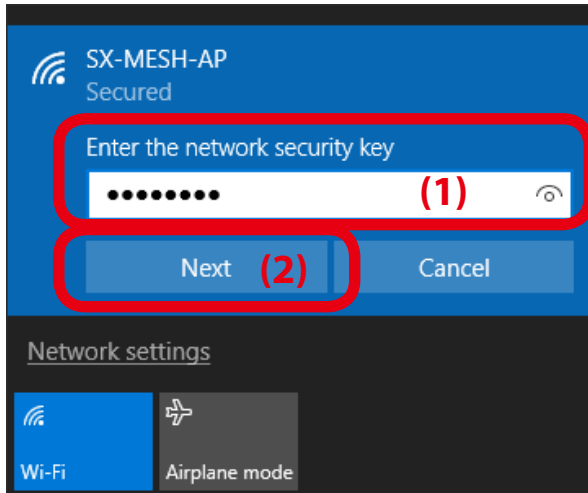

4. When the message "Connected" is displayed, the Windows PC has been connected to BR-400AN.

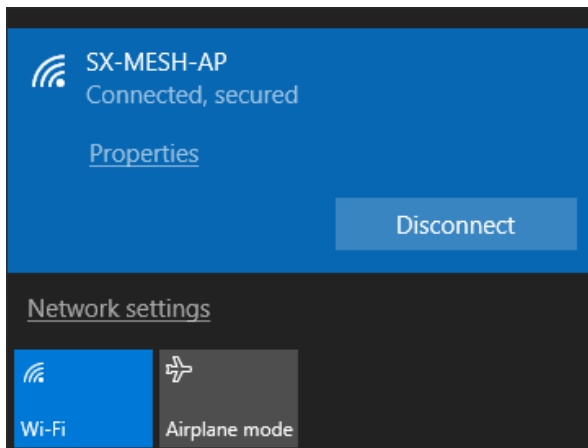

7. Maintenance Feature

This chapter explains the maintenance feature of BR-400AN.

7-1. Restart

Execute one of the following methods to restart BR-400AN.

- 1) Restart BR-400AN by unplugging the AC adaptor
- 2) Restart BR-400AN using the Web configuration interface
- 3) Restart BR-400AN using AMC Manager®



- For details on how to restart using AMC Manager®, see **4-9. Restart** in the AMC Manager® User's Manual.

Note

How to restart BR-400AN by unplugging the AC adaptor

1. Unplug the AC adaptor of BR-400AN from the outlet (1) and plug it back into the outlet (2).

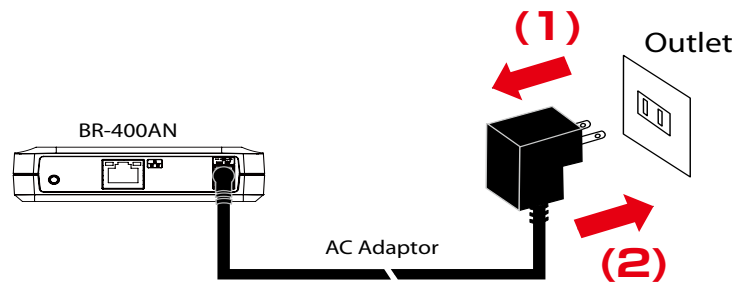

2. When the POWER LED turns green and WLAN LED turns or blinks green/orange, the restart is completed. After the restart, the BR-400AN will start in a normal mode.

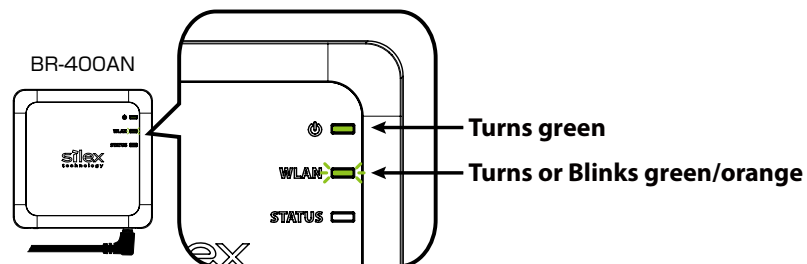

How to restart BR-400AN using the Web configuration interface

1. Access the Web configuration interface of BR-400AN using your Web browser, enter the password and click **Login**.

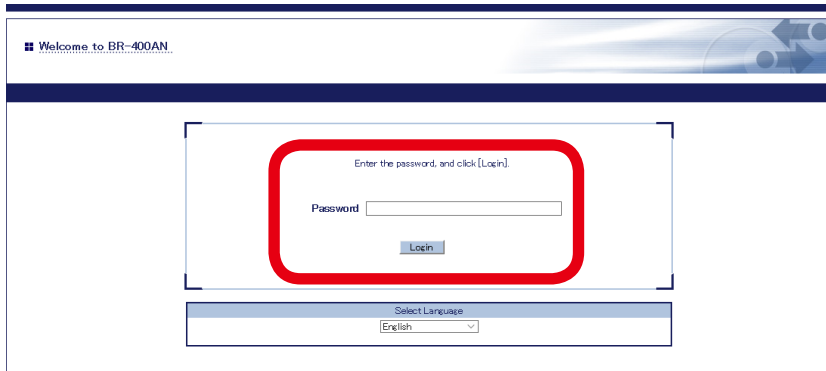

Note

- For how to access the Web configuration interface, refer to **4-1.Configuration via BR-400AN's Web Page**.
- When the password is not set to BR-400AN, the login password configuration page is displayed.

2. Click **Reboot** from the menu (1) and click **Yes** (2).

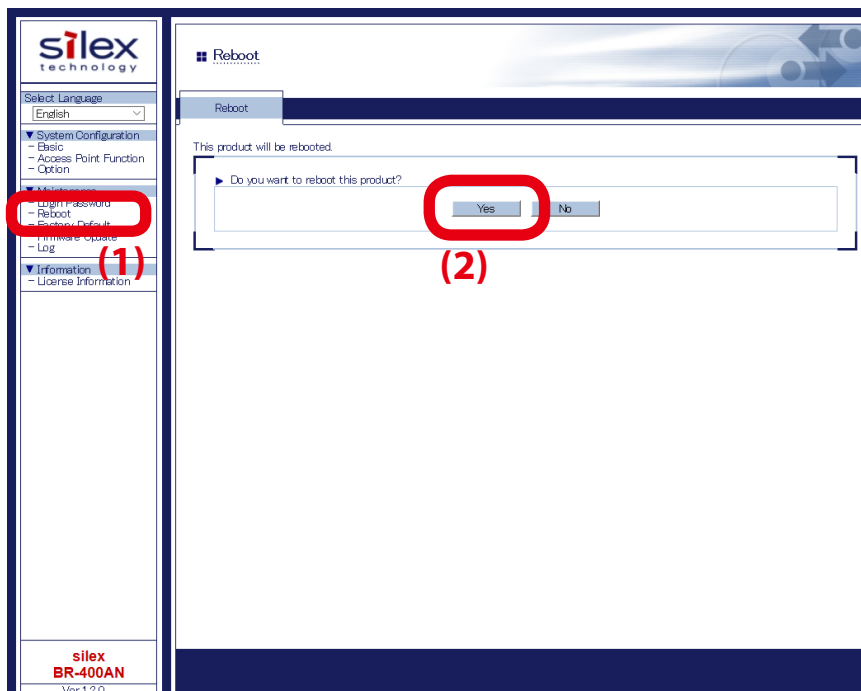

- 3.** The restart is completed when all LEDs turn off and then the POWER LED turns green and the WLAN LED turns or blinks green/orange. BR-400AN will run in a normal mode then.

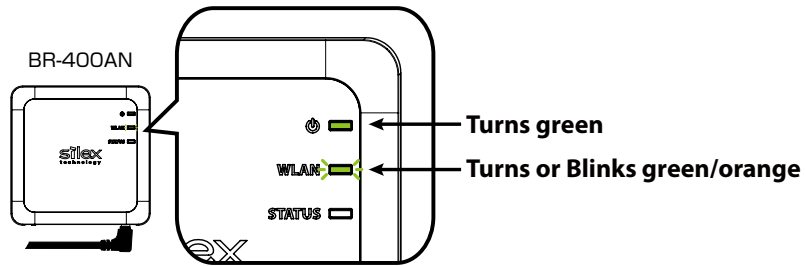

7-2. Factory Default Configuration

Execute one of the following methods to initialize BR-400AN.

- 1) Factory default configuration using the push switch of BR-400AN
- 2) Factory default configuration using the Web page of BR-400AN
- 3) Factory default configuration using AMC Manager®



Note

- For details on the factory default configuration using AMC Manager®, refer to **4-8. Factory Default Configuration** in AMC Manager® User's Manual.

How to reset BR-400AN to factory defaults using the Push Switch

1. Unplug the AC adaptor of BR-400AN from the outlet.

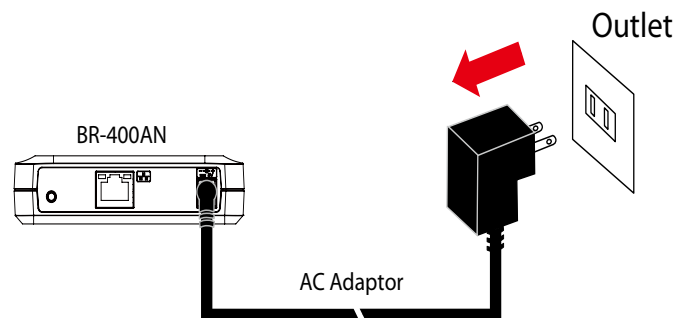

2. Press and hold the push switch on the front (1) while inserting the AC adaptor back into the electrical outlet (2).

When the WLAN LED turns Green then to Red (3), release the push switch (4).

After the factory default configuration is completed, BR-400AN starts in a normal mode.

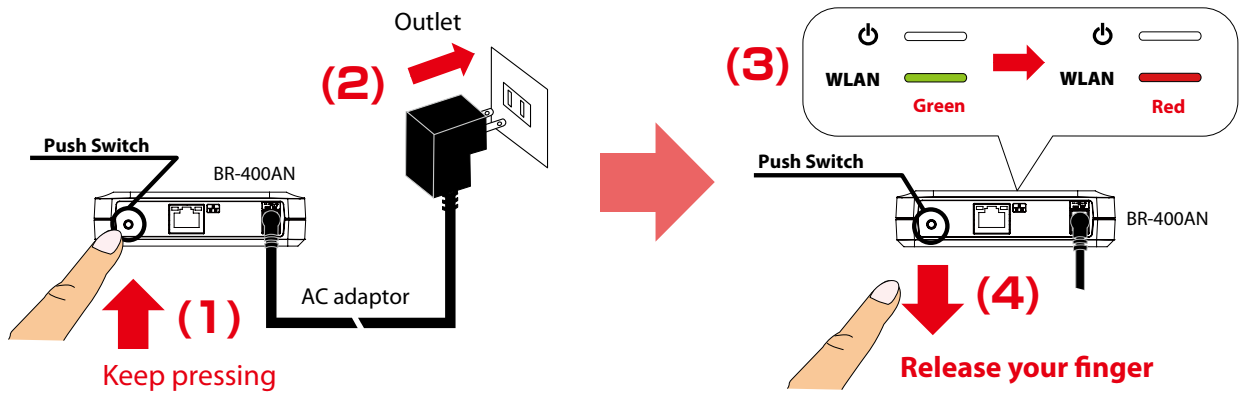

How to reset BR-400AN to factory defaults using the Web configuration interface

1. Access the Web configuration interface of BR-400AN using your Web browser, enter the password and click **Login**.

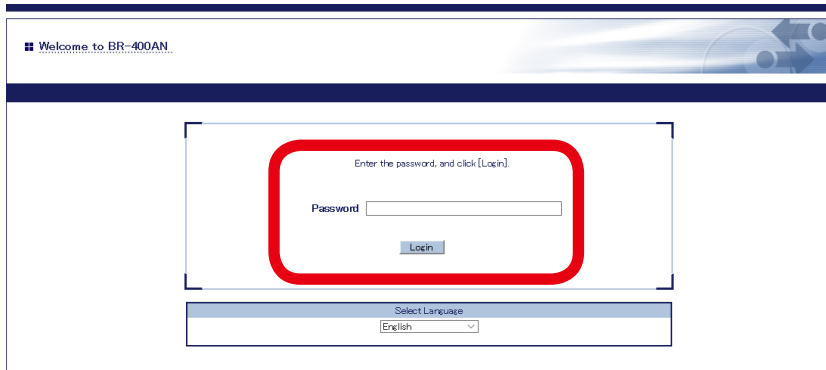

- For how to access the Web configuration interface, refer to **4-1.Configuration via BR-400AN's Web Page**.
- When the password is not set to BR-400AN, the login password configuration page is displayed.

Note

2. Click **Factory Default** from the menu (1) and click **Yes** (2).

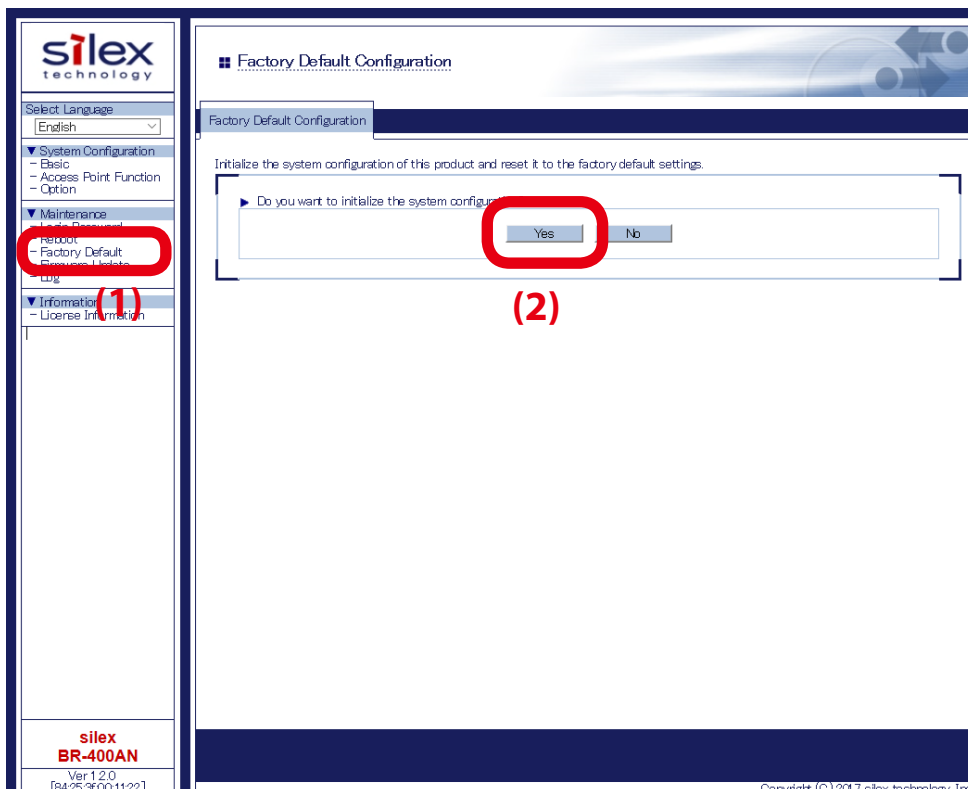

- 3.** When the factory default configuration is completed, BR-400AN is automatically restarted. When the restart is completed, the POWER LED turns green and the WLAN LED turns or blinks green/orange. BR-400AN will run in a normal mode then.

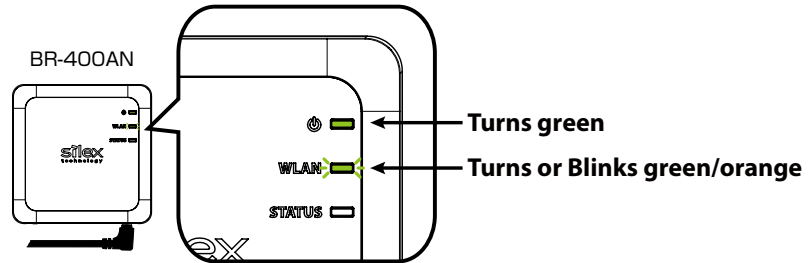

7-3. Firmware Update

The latest firmware file can be downloaded from our website.



Note

- The current firmware version can be identified at the bottom left of the Web configuration interface.

How to download the firmware file:

1. Access our website below.

URL	
USA / Europe	https://www.silextechnology.com/

2. Go to the support section and download the firmware file.

How to update the firmware:

How to update the firmware of BR-400AN is explained.

The firmware can be updated using the Web configuration interface.



Note

- The firmware update procedure is also described on the PDF file that comes with the firmware data.
- The firmware can also be updated using AMC Manager®. For details, refer to **4-7. Firmware Update** in AMC Manager® User's Manual.

1. Access the Web configuration interface of BR-400AN using your Web browser, enter the password and click **Login**.

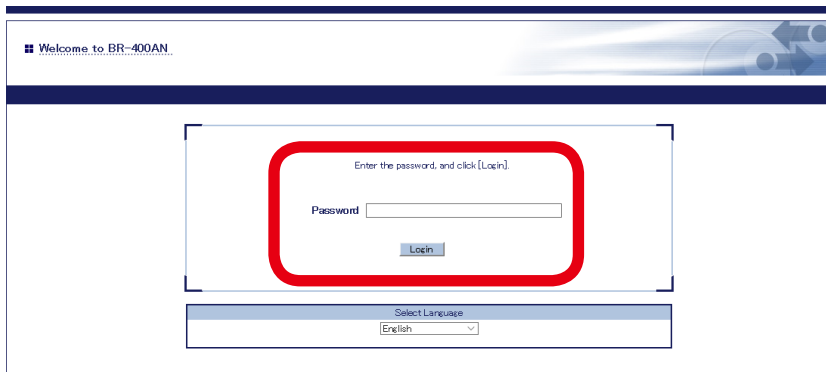

Note

- For how to access the Web configuration interface, refer to **4-1.Configuration via BR-400AN's Web Page**.
- When the password is not set to BR-400AN, the login password configuration page is displayed.

2. Click **Firmware Update** from the menu.

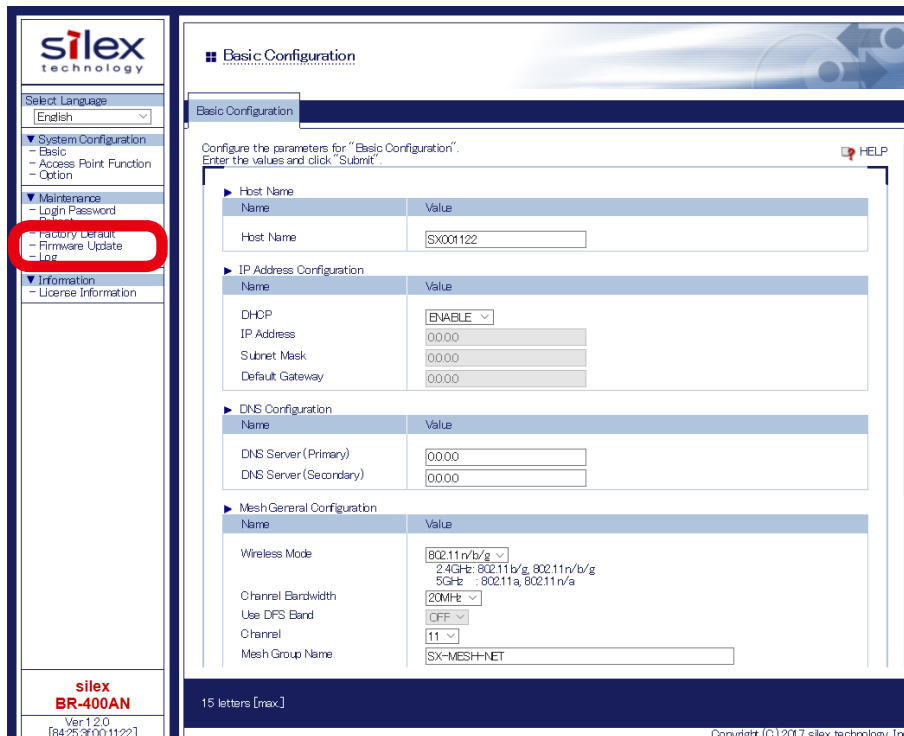

3. When the **Firmware Update** page is displayed, click **Browse**.

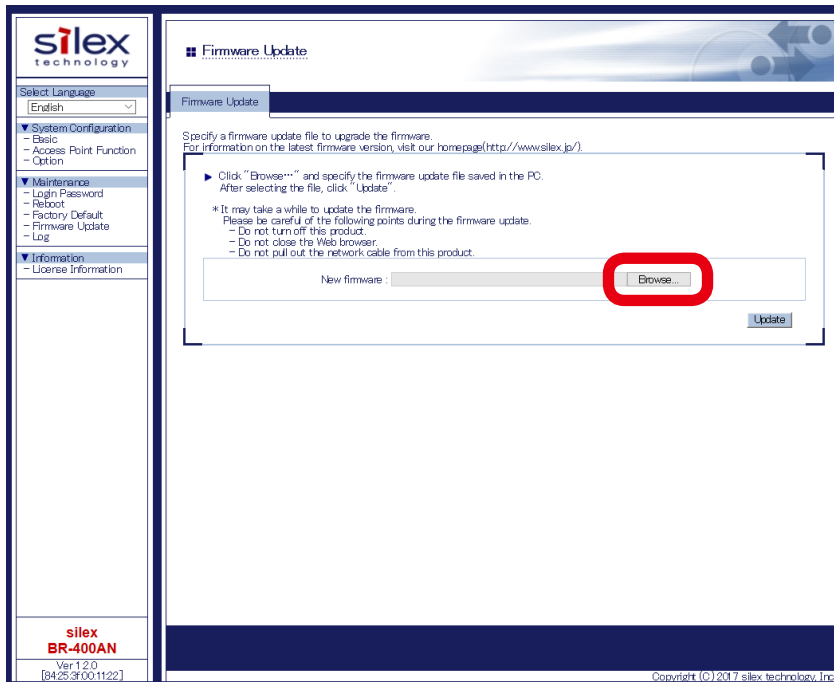

4. Select the firmware update file of BR-400AN (BR-400AN.bin) and click **Open**.

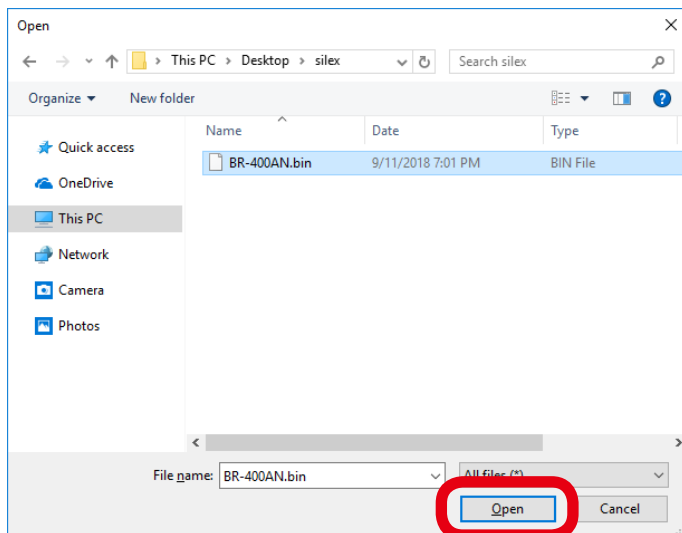

5. Check that the file name is displayed at **New firmware** field (1) and click **Update** (2).

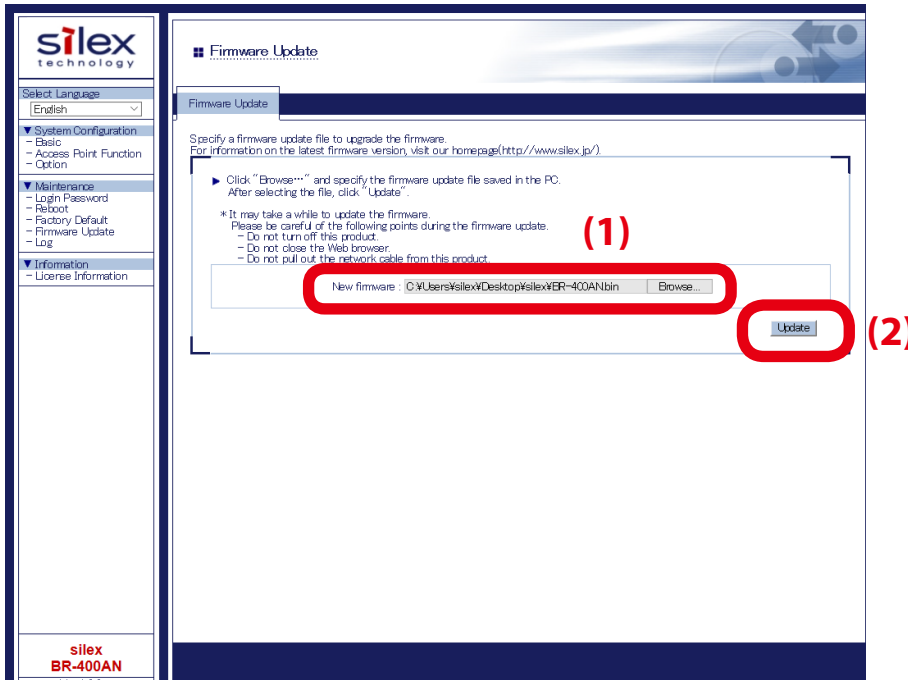

6. Click **OK** to the confirmation message.

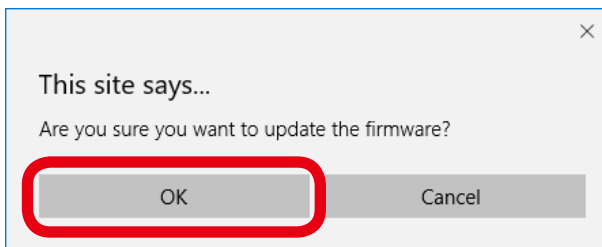

7. The firmware update will begin.
All LEDs on top of BR-400AN turn on while the firmware update is in process.



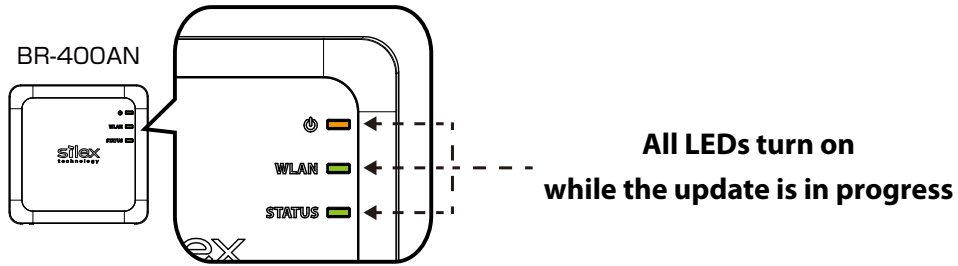

- Do not turn off BR-400AN or close your Web browser while the firmware update is in process.

8. When the firmware update is completed, the login page is displayed. Check the version information at the bottom left of the login page.

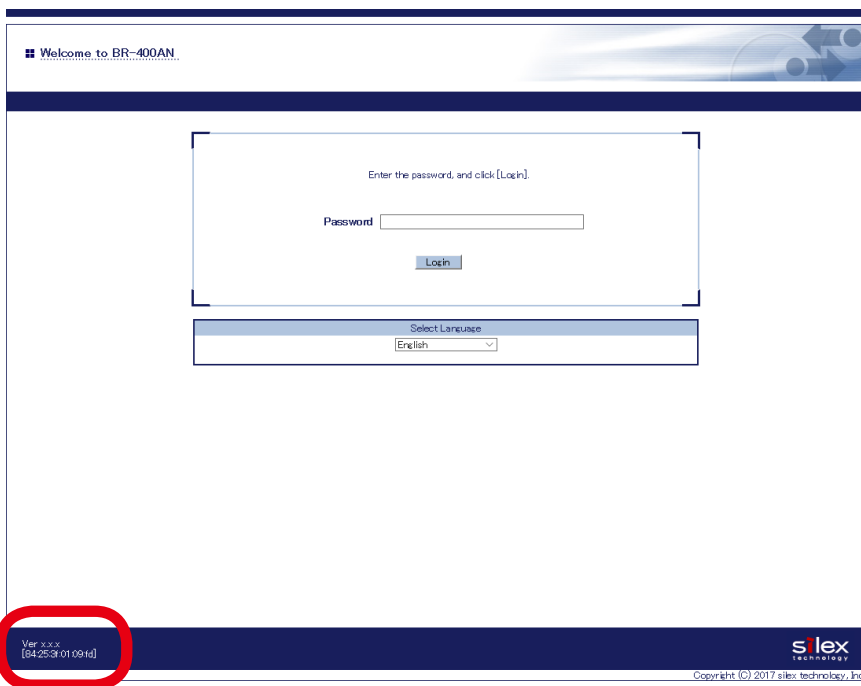

The firmware update has been completed.

8. Other Features

This chapter explains the other features of BR-400AN.

8-1. Mac Address Filter

The MAC Address filter function of BR-400AN works only when the Access Point feature is enabled. An access from the wireless client device can be filtered.

Filter Type

By registering the MAC Address to a list, access of wireless devices is allowed or denied based on the filter type below.

Name	Description
DISABLE	Does not use MAC Address filter. All devices are allowed to access.
ALLOW	Allows access only from devices with the registered MAC Address.
DENY	Denies access from devices with the registered MAC Address.

MAC Address List

Register the MAC Address of devices to allow/deny access to BR-400AN.
Up to 1024 MAC Addresses can be registered.

Example of MAC Address Registration

MAC Address Filter Configuration

Name	Value
Filter Type	ALLOW
MAC Address	84:25:3F:00:00:01 84:25:3F:00:00:02 84:25:3F:00:00:03 84:25:3F:00:00:04 84:25:3F:00:00:05 84:25:3F:00:00:06 84:25:3F:00:00:07 84:25:3F:00:00:08 84:25:3F:00:00:09 84:25:3F:00:00:0A
	84:25:3F:00:00:0B

Add Delete

MAC Address Filter Setting

The following explains how to configure the MAC Address filter.

1. Access the Web configuration interface of BR-400AN using your Web browser, enter the password and click **Login**.

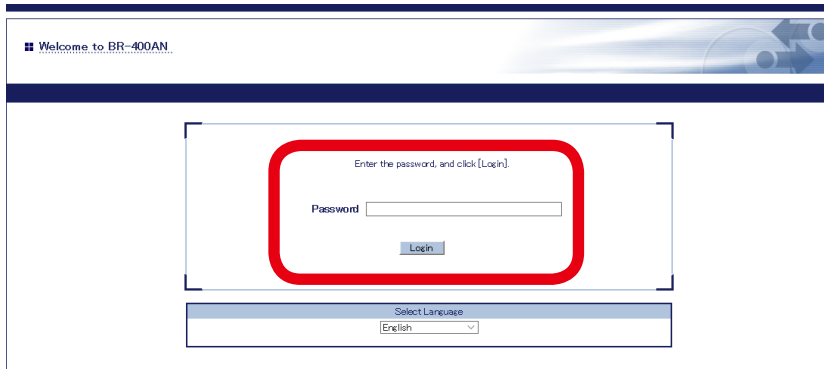

Note

- For how to access the Web configuration interface, refer to **4-1.Configuration via BR-400AN's Web Page**.
- When the password is not set to BR-400AN, the login password configuration page is displayed.

2. Click **Access Point Function** from the menu (1) and click the **Access Point Function Extended Configuration** tab (2).

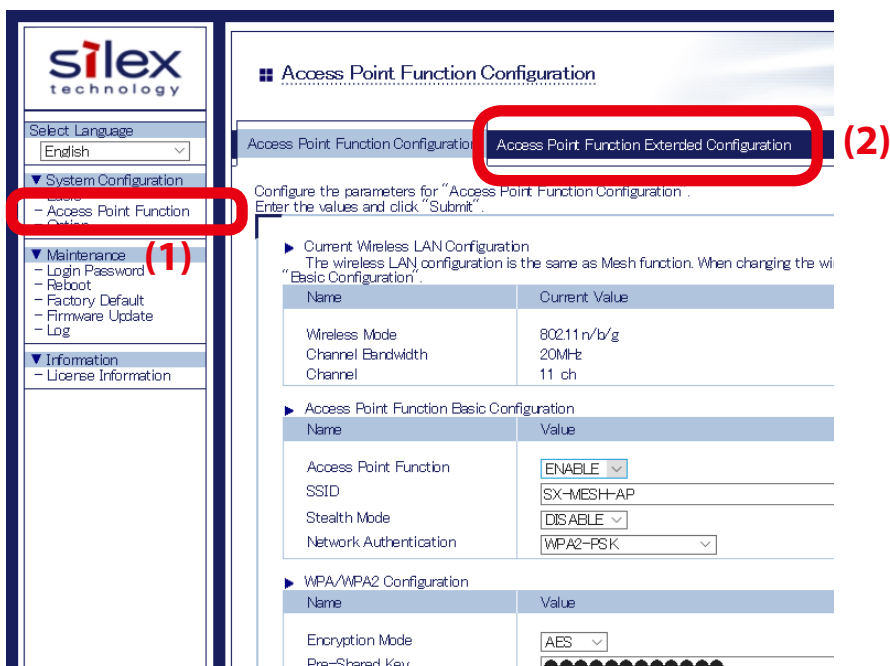

3. Select the filter setting at **Filter Type** (1). Enter the MAC Address of the wireless client device to filter an access from and click **Add** (2). The entered MAC Address is added to the list.

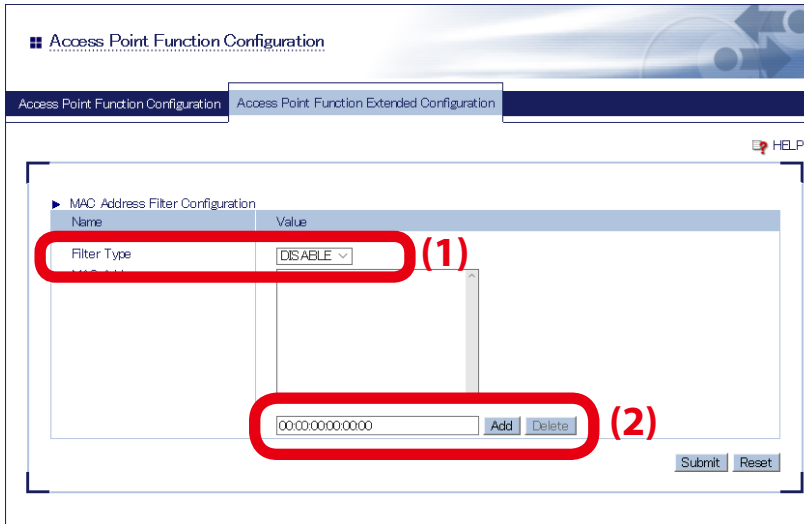

- To remove the registered MAC Address from the list, select the address and click **Delete**.

Note

4. When the address registration is completed, click **Submit**.

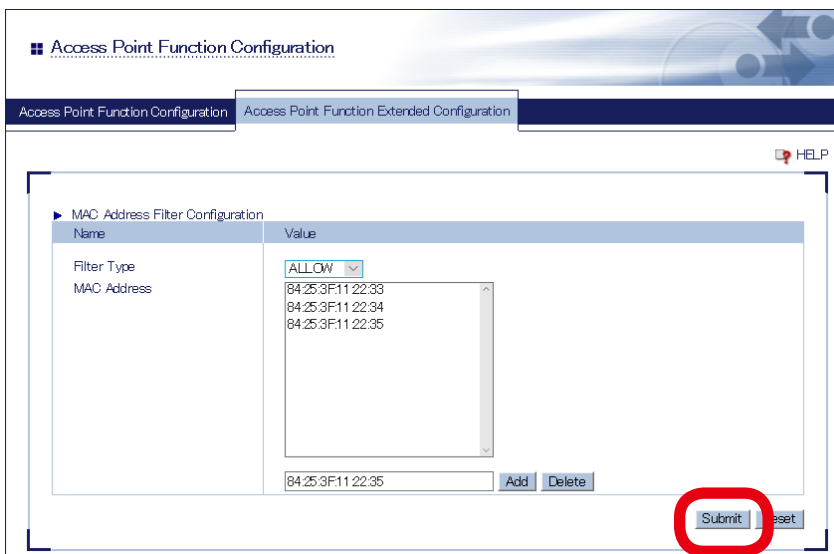

5. Restart BR-400AN.

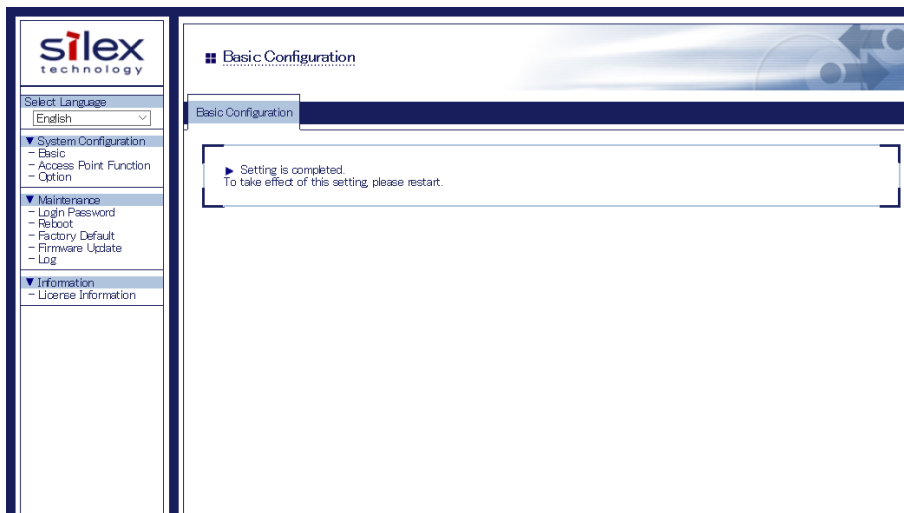

Note

- For how to restart BR-400AN, refer to **7-1. Restart**.
- The MAC Address filter setting will not take effect unless you restart BR-400AN.

8-2. Saving Log

BR-400AN can save the operating log.

Once the log is saved, it can be retrieved or deleted from the Web configuration interface.

BR-400AN's System Log

System Log

The power-on status, operating status, etc. of BR-400AN are saved as a log file.

In case of a network trouble, you can check the operating status by referring the retrieved system logs. The system log can be retrieved or deleted from the log page of Web configuration interface.

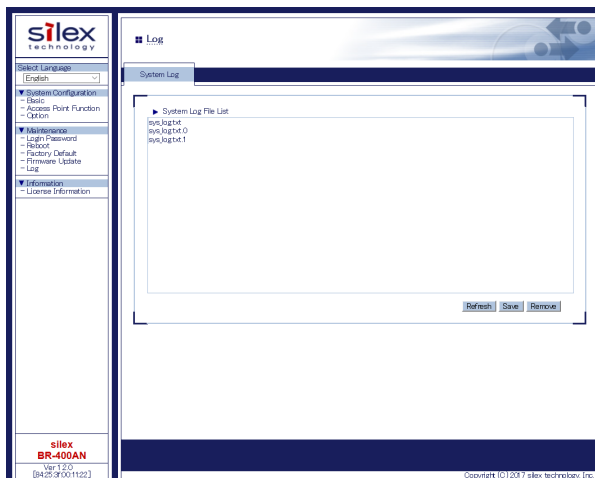

Note

- The system log file will remain even after BR-400AN is reset to factory defaults.
- When a size of log file (file name: sys_log.txt) exceeds 10MB, a new file is created. For the existing file, a number will be added to the end of the file name then.
- As the end number of the file name increases one by one when a new log file is created, files with a greater number will be older logs.
- Up to 99 log files can be saved, starting from sys_log.txt.0 to sys_log.txt.98.
- If a new file is created when 99 log files have already been there, the oldest file sys_log.txt.98 will be deleted.
- Up to 1GB log can be saved.

Retrieving System Log

The system log saved on BR-400AN can be accessed from the Web page.

1. Access the Web configuration interface of BR-400AN using your Web browser, enter the password and click **Login**.

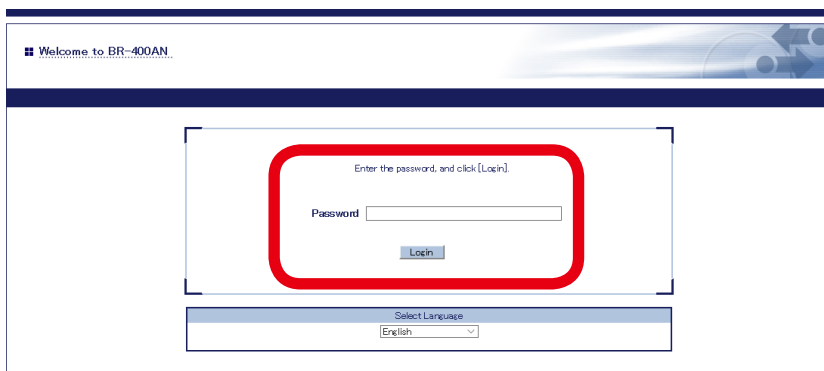

Note

- For how to access the Web configuration interface, refer to **4-1.Configuration via BR-400AN's Web Page**.
- When the password is not set to BR-400AN, the login password configuration page is displayed.

2. Select **Log** from the menu to display the syslog page (1).
Then, click **Save** to save the log information (2).

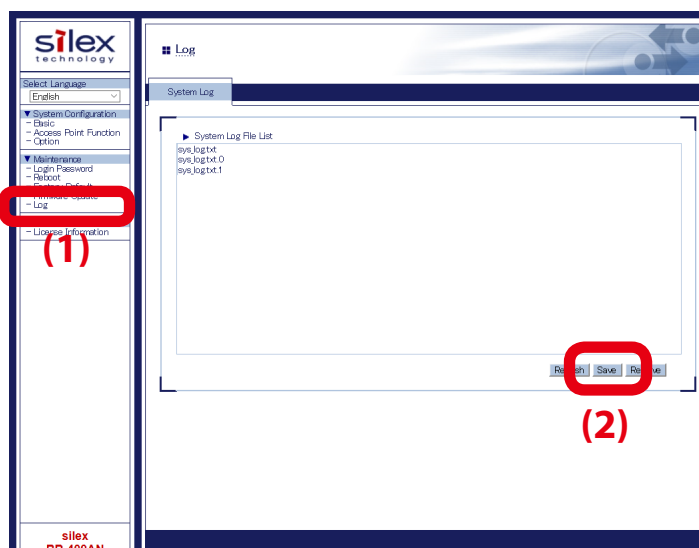

TIP

- The log files cannot be saved individually.

3. The confirmation message is displayed on which you can specify where the syslog file (sys_log_archive.tgz) should be saved. Click **Save** or **Save as**.

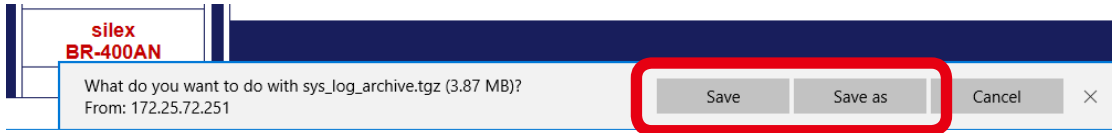

The system log has been saved.

Deleting System Log

The system log saved on BR-400AN can be deleted from the Web page.

1. Access the Web configuration interface of BR-400AN using your Web browser, enter the password and click **Login**.

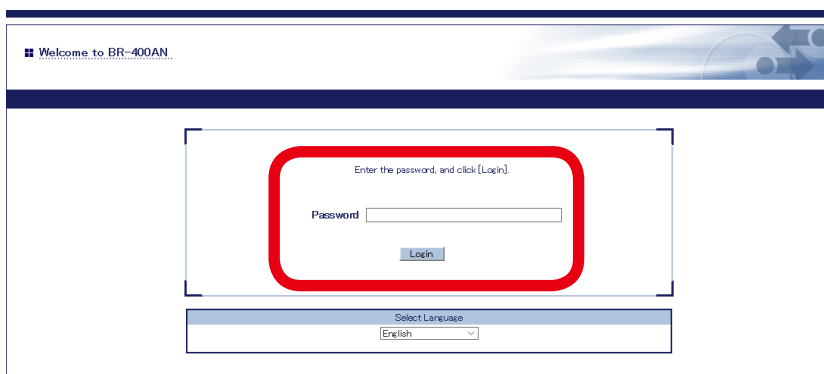

Note

- For how to access the Web configuration interface, refer to **4-1.Configuration via BR-400AN's Web Page**.
- When the password is not set to BR-400AN, the login password configuration page is displayed.

2. Select **Log** from the menu to display the syslog page (1). Then, click **Remove** to delete the log information (2).

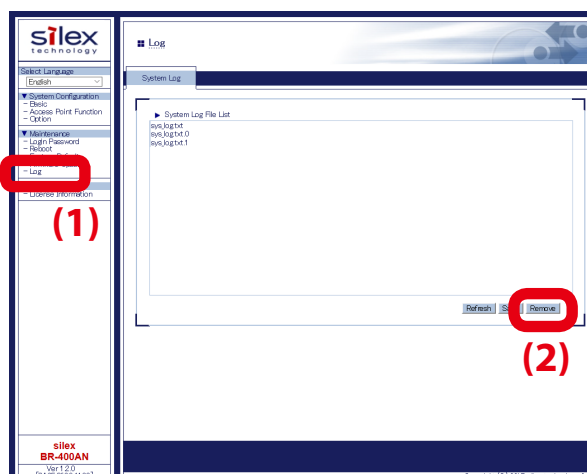

TIP

- The system log files cannot be deleted individually.

3. Click **OK** to a confirmation message.

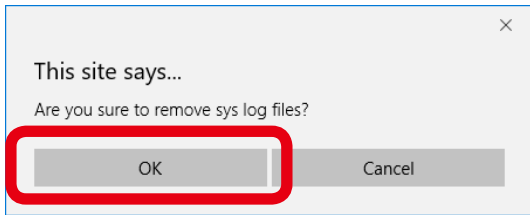

- If **Cancel** is clicked, the system log will not be deleted.

Note

The system log has been deleted.

A. Appendix

A-1. Troubleshooting

This chapter introduces the possible problems you may encounter while installing or using BR-400AN and the troubleshooting methods for those problems.

I don't know what IP address is assigned to BR-400AN.

Solution	Use the unified device management utility "AMC Manager [®] " or "AMC Manager [®] Free". They can discover BR-400AN units over the network.
----------	--

The POWER LED is blinking red.

BR-400AN may be connected to Ethernet HUB via wired LAN when it is operating in the configuration mode.	
Solution	Restart BR-400AN. To use BR-400AN in the configuration mode, connect BR-400AN directly to a PC.

BR-400AN fails to connect to the existing Mesh network.

The wireless setting or Mesh setting of BR-400AN may differ from the setting of that Mesh network.	
Solution	Configure the same wireless setting, Mesh group name and Mesh encryption key to BR-400AN as that of the Mesh network. These settings must be the same between the Mesh network and BR-400AN.

BR-400AN fails in communication with the target device.

The communication route to the target device may not have been established.	
Solution	Use Mesh Monitor to check if the communication route is established for the target device.

Communication speed is too slow.

The communication speed could be improved by changing the configuration of BR-400AN.	
Solution	<p>Change the location or configuration. Example)</p> <ul style="list-style-type: none"> - Select 802.11n/a for Wireless Mode and 40MHz for Channel Bandwidth. - When BR-400AN is not connected to Ethernet HUB, select DISABLE for Network Loop Avoidance. - Set a greater value for TX Power (e.g. 50% -> 70%). - Install more devices to shorten the interval of devices.

When BR-400AN is added to the existing network, a communication error occurs in the existing network.

BR-400AN may be connected to the existing network via wired LAN when Network Loop Avoidance is set to DISABLE on it.	
Solution	<p>Remove the BR-400AN unit from the network. Set ENABLE for Network Loop Avoidance on the BR-400AN unit and then add it back to the existing network. (By default, Network Loop Avoidance is set to ENABLE.)</p>

Although the Access Point feature is enabled on BR-400AN, I cannot connect a wireless client device.

The access may be filtered by the MAC Address filter.	
Solution	<p>The MAC Address filter works only when the Access Point feature is enabled on BR-400AN. Login to the Web configuration interface, click Access Point Function and select the Access Point Function Extended Configuration tab. Check if the MAC address filter is enabled. If you do not have a PC to access the Web configuration interface, initialize BR-400AN. For how to initialize, refer to 7-2. Factory Default Configuration - How to reset BR-400AN to factory defaults using the Push Switch.</p>

Communication is lost.

The route may not be optimized in the Mesh network.	
Solution	<p>When the Route Refresh Function is set to DISABLE, change it to ENABLE.</p>

BR-400AN of a different floor may have been connected to the Mesh network.

BR-400AN of a different floor could be connected if a radio wave is reached from that Mesh network.	
Solution	To establish the Mesh network separately for each floor, a different Mesh ID needs to be set for each network.

I cannot connect BR-400AN to the Mesh product of other vendor thought it supports IEEE802.11s.

Solution	BR-400AN does not support other manufacturer's Mesh products. The detailed specification differs for each manufacturer.
----------	--

BR-400AN is found on AMC Manager® but when I try to configure it, the message says "Failed to connect to the device" and the configuration fails.

BR-400AN and the PC you are using for configuration may be in a different network segment.	
Solution	If the IP address of BR-400AN is displayed as "169.254.x.x" on AMC Manager®, change the IP address and subnet mask of BR-400AN to the one communicable from the PC. Or otherwise, change the IP address and subnet mask of the PC to the one communicable with the address "169.254.x.x".

The communication quality is poor as I see it using Mesh Monitor.

One of terminal devices on the Mesh network may keep sending the broadcast packets.	
Solution	If a device continues to send broadcast packets in the Mesh network, it may cause traffic on the bandwidth and interfere with communications of other devices. Remove that device from the Mesh network or change the configuration not to send the broadcast packets.

BR-400AN falls into the 'undetected' status on Mesh Monitor when BR-400AN is using the DFS channel and the route refresh is executed on Mesh Monitor.

BR-400AN may be in a process of radio wave detection for 1min as it does not find other MP/MAP devices when the route refresh is executed.	
Solution	If MP/MAP devices are not found on the Mesh network after the route refresh is executed when BR-400AN is using the DFS channel, BR-400AN tries to see if there are radar signals. During this period, BR-400AN is not able to handle wireless communication and respond to Mesh Monitor for 1 min. To avoid this problem, use the other channel than the DFS channel.

When I configure BR-400AN using AMC Manager®, the message says "Invalid value is included" and the configuration fails.

You may try to configure BR-400AN with a combination of incompatible settings.	
Solution	<p>When you configure multiple settings of BR-400AN using AMC Manager®, the configuration can fail due to incorrect combination of settings.</p> <p>For example, the configuration fails when the selected extension channel does not exist on the communication channel, when invalid WEP key or Pre-Shared Key is specified, or when WEP is configured for 802.11n/b/g or 802.11n/a even though these wireless modes do not support WEP.</p> <p>Example of bad combination of settings:</p> <ul style="list-style-type: none"> - Wireless mode is set to 802.11b/g or 802.11a and channel bandwidth is set to 40MHz. - Wireless mode is set to 802.11n/b/g or 802.11n/a and WEP is set to ENABLE. - Wireless mode is set to 802.11n/a, the communication channel is set to 36, 52, 100, and extension channel is set to Lower. - Wireless mode is set to 802.11n/a, the communication channel is set to 48, 64, 140, and the extension channel is set to Upper. - Wireless mode is set to 802.11n/b/g, the communication channel is set to 1, 2, 3, 4, and the extension channel is set to Lower. - Wireless mode is set to 802.11n/b/g, the communication channel is set to 8, 9, 10, 11 (for US) or 10, 11, 12, 13 (for EU), and the extension channel is set to Upper. - WEP is set to ENABLE and values other than below are specified for WEP key. <ul style="list-style-type: none"> • 5-10 digit character string • 13 or 26 digit hexadecimal value - Wireless mode is set to 802.11n/b/g, 802.11n/a or the authentication method that include WPA2 is used, and then TKIP is used for encryption mode. - Pre-Shared Key is specified by 64 characters. <p>Please try to configure BR-400AN again using the correct settings.</p>